

**M Class**  
**Operation Manual**

# **M Class**

## **Laser Engraving and Cutting System Operations Manual**

**Manufactured by:  
Universal Laser Systems, Inc.**

16008 North 81st Street  
Scottsdale, AZ 85260  
Phone: 480-483-1214  
Fax: 480-483-5620

**March 1999**

## Notice

This publication and its contents are proprietary to Universal Laser Systems, Inc. (ULS), and are intended solely for the contractual use of ULS, Inc. customers.

While reasonable efforts have been made to assure the accuracy of this manual, ULS shall not be liable for errors contained herein or for incidental or consequential damage in connection with the furnishing, performance, or use of this material.

ULS reserves the right to revise this manual and make changes from time to time without obligation by ULS to notify any person of such revision or changes.

ULS does not assume any liability arising out of the application or use of any products, circuits, or software described herein. Neither does it convey a license under its patent rights nor the patent rights of others.

This publication and its contents may not be reproduced, copied, transmitted, or distributed in any form, or by any means, radio, electronic, mechanical, photocopying, scanning, facsimile, or otherwise, or for any other purpose, without the prior written permission of ULS.

ULS provides no warranties whatsoever on any software used in connection with a ULS Laser Engraving System, express or implied. Neither does it guarantee software compatibility with any off-the-shelf software package or any software program that has not been written by ULS.

Intended use of this system must be followed within the guidelines of this manual. In no event will ULS be liable for any damages caused, in whole or in part, by customer, or for any economic loss, physical injury, lost revenue, lost profits, lost savings or other indirect, incidental, special or consequential damages incurred by any person, even if ULS has been advised of the possibility of such damages or claims.

HP is a registered trademark of Hewlett-Packard Company.

Windows is a registered trademark of Microsoft Corporation.

Macintosh is a registered trademark of Apple Computer Corporation.

PostScript, Photoshop, and Streamline are registered trademarks of Adobe Systems Inc.

CorelDraw is a registered trademark of Corel Corporation.

AutoCad is a registered trademark of Autodesk Inc.

**© Universal Laser Systems Inc., 1999  
By Vince Budetti  
All Rights Reserved**

## Introduction

Thank you for purchasing the M Class Laser System. Years of testing and refinements have made this unit the ultimate laser engraving and cutting system. With its small footprint design and large engraving area, the M Class combines flexibility and full featured performance without sacrificing simplicity, ease of use, and ease of maintenance. Using advanced engineering and design features, the M Class is truly one-of-a-kind. Actually, the M Class is such a breakthrough in technology that it is more than just a laser system, it is a precision engraving and cutting device used as a tool for the imagination.

To begin with, we highly recommend that this entire manual be read before attempting to use the laser system. The manual includes important information about safety, assembly, use, and maintenance. **We cannot overemphasize the importance of reading the Operation Manual completely.**

## How To Get Help

### Step 1:

Determine exactly what the problem is. Try to recreate the problem and write down the circumstances in which the problem occurred. Be prepared to describe all pertinent information about the computer being used with the laser cutting and engraving system such as software, operating system and computer type. Have the serial number of the laser system available. The serial number tag is located on the back of the machine in the lower right corner. There is a second serial tag located behind the front door on the right side when you open it.

### Step 2:

Contact your local Sales Representative first to assist you in diagnosing the problem. If possible, call from a phone that is close to the laser engraving system so that the system can be operated while talking to our representative.

### Step 3:

If your local Sales Representative is unavailable, contact our Customer Service Department at:

Universal Laser Systems, Inc.  
Service/Parts Department  
7707 East Acoma Drive, Suite 108  
Scottsdale, AZ 85260  
Phone: 480-609-0297  
Fax: 480-609-1203  
Email: [service@ulsinc.com](mailto:service@ulsinc.com)  
M-F 8am – 5pm Arizona Time

---

# Contents

- SECTION 1 - Safety..... 1-1**
  - Description of Appropriate Use..... 1-1
  - General Safety ..... 1-1
  - Laser Safety..... 1-2
  - Laser Safety Labels ..... 1-3
  - Other Safety Labels ..... 1-6
  - FCC Compliance..... 1-7
  - EU Compliance (CE) ..... 1-8
  
- SECTION 2 - Installation..... 2-1**
  - Operating Environment..... 2-1
  - Electrical Requirements ..... 2-2
  - Exhaust Requirements ..... 2-3
  - Unpacking and Assembling the System..... 2-5
  - Computer Requirements ..... 2-5
  - Software Suggestions ..... 2-5
  - Font Requirements ..... 2-6
  - Making the Connections ..... 2-7
  
- SECTION 3 - The Printer Driver ..... 3-1**
  - How the Computer Controls the Laser System ..... 3-1
  - Installing the Windows 95 Printer Driver ..... 3-2
  - Driver Controls..... 3-3
  
- SECTION 4 - Graphics Software ..... 4-1**
  - Software Setup ..... 4-1
  - Speed Optimizing ..... 4-4
  - Bitmapped / Scanned Images ..... 4-4
  - Encapsulated Postscript (EPS) Images ..... 4-6
  - Postscript (PS) Images ..... 4-6

---

<b>SECTION 5 - System Operation.....</b>	<b>5-1</b>
How it Works .....	5-1
The Control Panel.....	5-3
The Menu System.....	5-7
Menu Descriptions .....	5-8
Focusing the Laser Beam .....	5-21
<b>SECTION 6 - Running the System Step by Step.....</b>	<b>6-1</b>
Powering Up .....	6-1
Loading and Positioning the Material .....	6-2
Focusing Methods .....	6-2
Creating the Graphic.....	6-3
Setting the Drivers Properties .....	6-3
Downloading the File .....	6-5
Starting the Engraving Process.....	6-5
Material Removing and Reloading.....	6-6
<b>SECTION 7 - Options &amp; Accessories .....</b>	<b>7-1</b>
3D Effects .....	7-1
Rotary Fixture .....	7-5
Cutting Table.....	7-6
Air Assist System .....	7-7
Air Assist Compressor .....	7-7
Focus Lens Kits.....	7-8
<b>SECTION 8 - Sample Materials .....</b>	<b>8-1</b>
Safety.....	8-1
Acrylic - Cast and Extruded.....	8-3
Acrylic - Mirrored.....	8-5
Anodized Aluminum .....	8-7
Brass - Coated .....	8-8
Corian / Avonite / Fountainhead.....	8-9
Cork.....	8-10

---

Delrin (Seal Press) .....	8-11
Glass / Crystal .....	8-12
Leather .....	8-13
Marble .....	8-14
Mat Board.....	8-15
Melamine.....	8-16
Melamine - Photo / Clipart Engraving .....	8-17
Plastic - Engravers Microsurfaced .....	8-18
Rubber Stamps / Pre-Inked Stamps .....	8-19
Sign Vinyl .....	8-20
Wood / Wood Inlay .....	8-21

**SECTION 9 - Maintenance ..... 9-1**

Suggested Cleaning and Maintenance Supplies .....	9-1
System Cleaning .....	9-3
Optics Cleaning .....	9-3
AUTOFOCUS Sensor and Reflector.....	9-6
Adjustments and Lubrication .....	9-7
Electronic Upgrading .....	9-7
Fuse Replacement .....	9-7
Battery Replacement.....	9-7
Cooling Fan Filter(s) .....	9-8
Maintenance Schedule .....	9-8

**Appendix**

Warranty .....	A
Specifications .....	B
Using DOS Based Programs.....	C
Using Macintosh Computers .....	D
Serial Cable Requirements .....	E
Software Anomalies.....	F

---

## SECTION 1

# Safety

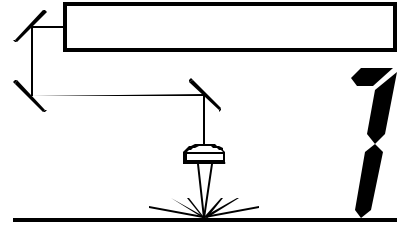

This section describes hazards that may occur if the laser system is installed or used improperly. Failure to follow these guidelines can result in injury to yourself, others, or may cause severe damage to the equipment. Use, misuse, or abuse of the equipment in a manner other than what is described in this manual may increase this risk. Operation and care of the laser system must be followed in strict accordance to this manual.

## Description of Appropriate Use

ULS laser systems are designed for cutting and engraving of the materials listed in this manual in laboratory, workshop or light duty manufacturing environments. Laser systems must be properly installed and connected to an appropriate exhaust system meeting the specifications outlined in this manual. Materials to be processed must fit completely inside the system for proper operation.

## General Safety

- **Exposure to the laser beam may cause physical burns and can cause severe eye damage.** Proper use and care of this system are essential to safe operation.
- **Never operate the laser system without constant supervision of the cutting and engraving process.** Exposure to the laser beam may cause ignition of combustible materials and start a fire. A properly maintained fire extinguisher should be kept on hand at all times.
- **A properly configured, installed, maintained, and operating fume/smoke exhaust system is mandatory when operating the laser system.** Fumes and smoke from the engraving process must be extracted from the laser system and exhausted outside.
- **Some materials, when engraved or cut with a laser, can produce toxic and caustic fumes.** We suggest that you obtain the Material Safety Data Sheet (MSDS) from the materials manufacturer. The MSDS discloses all of the hazards when handling or processing that material. The law requires all manufacturers to provide this information to anyone who requests it. **DISCONTINUE** processing any material that shows signs of chemical deterioration of the laser system. Systems damaged from this abuse will **NOT** be covered under warranty.
- **Dangerous voltages are present within the electronics and laser enclosures of this system.** Although access to these areas is not necessary during normal use, if it becomes necessary to open one of these enclosures for service reasons please remember to unplug the machine first.



## 1-2 Safety

---

- **Care should be taken when moving or lifting the laser system.** Obtain assistance from 1 or 2 additional people when lifting or carrying the system. Severe bodily injury may occur if improper lifting techniques are applied. Be careful not to drop the laser system. Not only can it cause bodily harm, but it can also severely damage the equipment and render it inoperable.
- **The laser system is specifically designed to comply with CDRH performance requirements under 21 CFR 1040.10 and 1040.11.** CDRH is the Center for the Devices of Radiological Health division of the Food and Drug Administration (FDA). This laser system also complies with CE (European Community) safety regulations. No guarantees of suitability or safety are provided for any use other than those specified by Universal Laser Systems Inc. Please contact Universal Laser Systems Inc. with any questions concerning laser safety before operating this system.

## Laser Safety



**The laser system contains a sealed carbon dioxide (CO<sub>2</sub>) laser that produces intense and invisible laser radiation at a wavelength of 10.6 microns in the infrared spectrum.** This laser system contains a CO<sub>2</sub> laser in a Class I enclosure. However, due to the presence of a visible red laser diode, the entire laser system is classified as Class 3a.

- The entire system is completely enclosed with a protective housing. This will completely contain the invisible CO<sub>2</sub> laser beam under normal use. However, the red diode laser is a visible laser beam. **DO NOT STARE INTO BEAM OR VIEW DIRECTLY WITH OPTICAL INSTRUMENTS.**
- The user door(s) are safety interlocked and will disable the CO<sub>2</sub> laser beam from firing when the user door(s) are opened. The control panel will also display a flashing “RED” light to visually indicate that the safety interlock system has been activated. The red diode laser beam is **NOT** safety interlocked and can be activated with the door(s) either open or closed.

## CO<sub>2</sub> INTERLOCK INDICATOR LIGHT

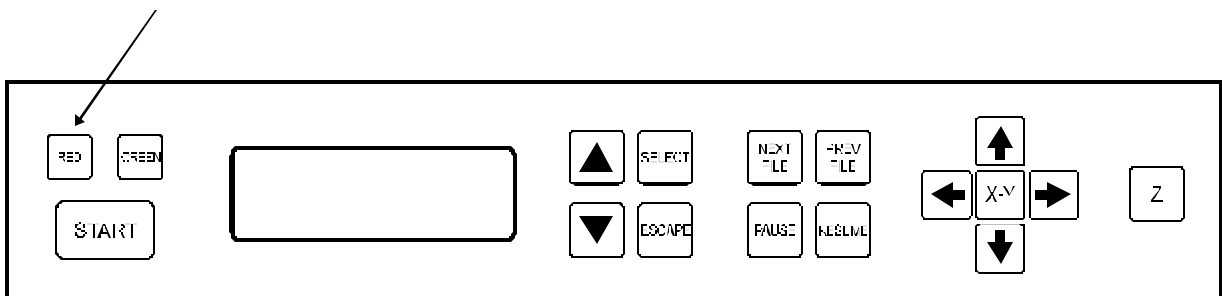



**Do not modify or disable any safety feature of this system. Do not operate any system that has had its safety features modified, disabled, or removed.** Improper use of controls and adjustments, or performance of procedures other than those specified in this manual, may invalidate the safety of this system.



**Do not stare into the beam or view directly with any optical instrument.** This laser system is equipped with a visible, red diode pointing laser and is considered a Class 3A device by CDRH and CE.

## Laser Safety Labels

CDRH and CE regulations require all laser manufacturers to affix warning labels in specific locations throughout the equipment. The following warning labels are placed on the laser system for your safety. **DO NOT** remove them for any reason. If the labels become damaged or have been removed for any reason, **DO NOT OPERATE** the laser system and immediately contact Universal Laser Systems Inc. for a free replacement.

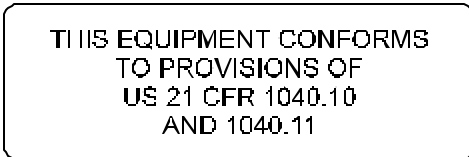

Location (1): On the back of the system next to the serial number tag. Visible when viewing the laser system from the backside.

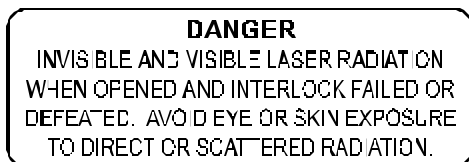

Location (4): One is on the top door and visible under normal operation. The second is located inside the laser system on the back panel, visible only when the top door is opened. The third is on the outside of the front door, and visible under normal operation. The fourth is located on the inside of the front door, visible only when the front door is opened.



Location (3): One is next to the Beam Window where the laser beam enters the engraving area inside the laser system and is visible when the top door is opened. The second one is located inside the output optics cover of the laser tube assembly that is not visible under normal operating conditions. The third is located on the outside of the laser tube assembly. The second and third locations are only visible if the laser tube assembly is removed for service and is not visible under normal operating conditions.

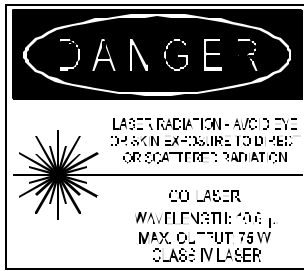

CDRH

Or

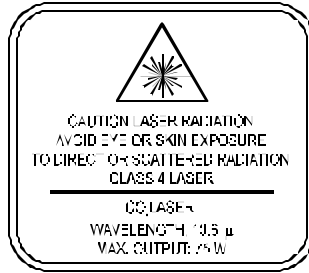

CE

Location (1): Affixed to the back of the laser tube assembly. Not visible under normal operating conditions. Only visible if laser tube rear enclosure is removed for service.

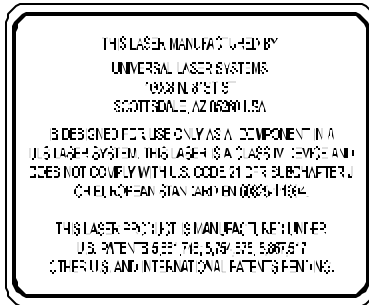

Location (1): Affixed to the back of the laser tube assembly. Not visible under normal operating conditions. Only visible if laser tube assembly is removed for service.

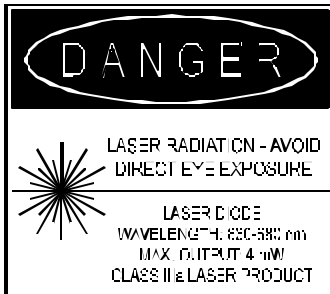

CDRH

Or

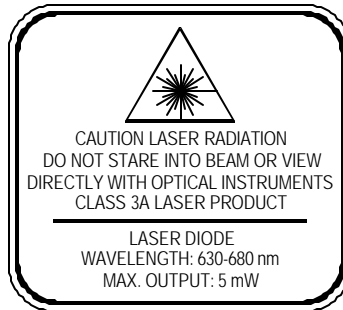

CE

Location (1): On the outside of the top door. Visible from the outside under normal operating conditions with the door closed.

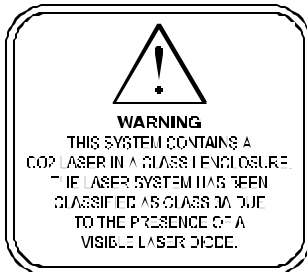

Location (1): On the outside of the top door. Visible from the outside under normal operating conditions with the door closed.

# Other Safety Labels

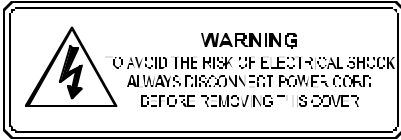

Locations (1 or 2): One is on the back of the laser system's cooling fan cover. Visible from the outside under normal operating conditions when viewed from the backside of the system. The other is on the plastic shield over the back of the power entry module on some models.

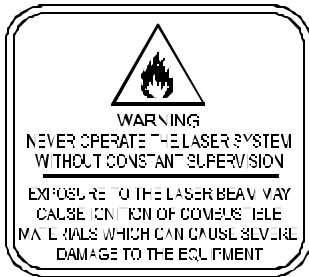

Location (1): On the outside of the top door. Visible from the outside under normal operating conditions with the door closed.

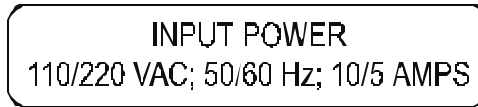

Location (1): On the side of the laser system next to the ON/OFF switch and plug receptacle. Visible from the outside under normal operating conditions.



Location (1): Inside of the laser system's cooling fan cover next to the chassis ground green wire. Not visible under normal operating conditions. Visible only when cover is removed for servicing only.

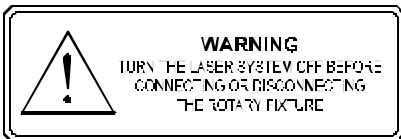

Location (1): On the outside motor cover of the optional Rotary Fixture. Visible under normal operating conditions.



Location (1): On the back side of the laser system in the lower right corner if viewing the machine from the backside. Visible under normal operating conditions.

## Serial Tag

## FCC Compliance

This ULS laser system has been tested and found to comply with Federal Communication Commission (FCC) directives regarding Electromagnetic Compatibility (EMC). In accordance with these directives ULS is required to provide the following information to its customers.

### **FCC Compliance Statement and Warnings**

This device Complied with FCC Rules Part 15. Operation is subject to the following two conditions:

1. This device may not cause harmful interference, and
2. This device must accept any interference received, including interference that may cause undesired operation.

This equipment has been tested and found to comply with the limits for a Class A digital device as set forth in Part 15 of the FCC Rules. These limits are designed to provide reasonable protection against harmful interference when the equipment is operated in a commercial environment. This equipment generates, uses and can radiate radio frequency energy and, if not installed and used in accordance with manufacturer's instructions, may cause harmful interference to radio communications. Operation of this equipment in a residential area is likely to cause harmful interference in which case the user will be required to correct the interference at his or her own expense.

Users should be aware that changes or modifications to this equipment not expressly approved by the manufacturer could void the user's authority to operate the equipment.

This equipment has been type tested and found to comply with the limits for a Computing Device per FCC part 15, using shielded cables. Shielded cables must be used in order to insure compliance with FCC regulations.

# EU Compliance (CE)

## EU Declaration of Conformity

**UNIVERSAL**  
LASER SYSTEMS INC.

**Product Identification:** M Class Laser Cutting and Engraving System

**Manufacturer:** Universal Laser Systems, Inc.  
16008 N. 81<sup>st</sup> St.  
Scottsdale, AZ 85260  
USA

Universal Laser Systems, Inc. hereby declares that the equipment specified below is in conformity with the following directives:

89/336/EEC (EMC Directive)  
73/23/EEC (Low Voltage Directive)  
89/392/EEC (Machinery Directive)

based on the standards listed.

**Standards Used:**

Safety:

EN 60950: 1995  
EN 60825: 1994 (Class IIIa)

EMC:

EN 55022: 1995 (Class A)  
EN 50082-1: 1992  
EN 60801-2: 1993 (6kV CD, 8kV AD)  
EN 61000-3-2: 1996 (class A)  
EN 61000-3-3: 1995  
EN 61000-4-3: 1997 (3 V/m)  
EN 61000-4-4: 1995 (2 kV power line, 0.5 kV signal line)  
EN 61000-4-5: 1996 (class 2)

**Manufacturer's Contact:**

Chris Risser, Compliance Engineer



Signature

1998

Date

**Warning** - This is a Class A product. In a domestic environment this product may cause radio interference in which case the user may be required to take adequate measures.

---

## SECTION 2

# Installation

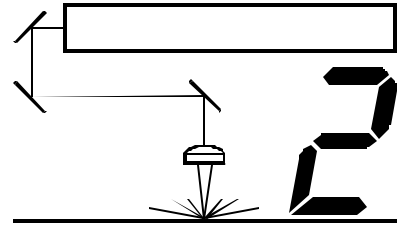

Proper operating conditions are vital to a safe and productive environment. This section describes the ideal environment and setup of the laser system.

## Unpacking and Assembling the System

Since packaging can change from time to time, please refer to any unpacking or assembly instructions that may be found inside of the shipping container when you first opened it.

## Operating Environment

Follow these guidelines to ensure a proper operating environment for the laser system. Operating the laser system outside of these guidelines can seriously damage the laser system and damages from this type of abuse **WILL NOT** be covered under warranty. Although conforming to these guidelines will greatly reduce the chance of a problem occurring, it does not guarantee it. **It is your responsibility to provide a proper operating environment.**

- Ambient room temperature **MUST** be between 58 and 85 degrees F (15 and 30 degrees C). If transporting the laser system from a very cold or very hot environment to the proper operating environment, the laser system must be allowed time to adjust to the ambient temperature. To do this, turn ON the laser system (and chiller if applicable), and let the system idle for 15 minutes before processing materials. This will allow the ambient temperature to circulate through the laser system to either warm it up or cool it off.
- Ambient room dewpoint temperatures **MUST** be less than 50 degrees F (10 degrees C).
- The laser system **MUST** be installed in an office type environment. Dusty or dirty air environments can damage the laser system. Keep the laser system isolated from any type of sandblasting, sanding, or any other machinery that produces airborne particles.
- Avoid small, enclosed, non-ventilated areas. Some materials, after laser engraving or cutting, continue emitting fumes for several minutes after processing. Having these materials present in a confined, unventilated room can contaminate the room.
- Choose a place, which provides the shortest and most direct path to the exhaust ductwork (not provided). Refer to exhaust requirements later on in this section.
- Have a work table or storage area next to or nearby the laser system. This prevents the operator from using the system as a table or storage facility.
- Do not move, push, lean on, or jar the laser system while it is engraving. The material you are engraving can shift and produce unsatisfactory results.

## 2-2 Installation

---

- If planning to connect the laser engraving system to a computer through the parallel port, choose a location where the computer can be placed within 10 feet of the machine since this is the maximum recommended parallel cable length.
- If connecting an additional laser system or other printer to the same computer, we recommend the installation of an additional parallel port into the computer. **DO NOT** use a manual A/B type switch box. This creates electrical noise, which can cause an engraving problem or can damage the laser system and/or the computer's electronics.

## Electrical Requirements

Please refer to the "INPUT POWER" sticker near the system's ON/OFF switch and power inlet for your system's electrical requirements. Make sure that your electrical outlet is capable of providing the proper voltage, frequency and amperage that your laser system needs.

Noisy or unstable electricity as well as voltage spikes can cause interference and possible damage to the electronics of the laser system. Connect the laser system to a dedicated electrical line if this is a problem in your building.

An IT type of electrical supply is acceptable if a standard power source is unavailable. An IT power system is a power distribution system having no direct connection to earth, the exposed conductive parts of the electrical installation being earthed.

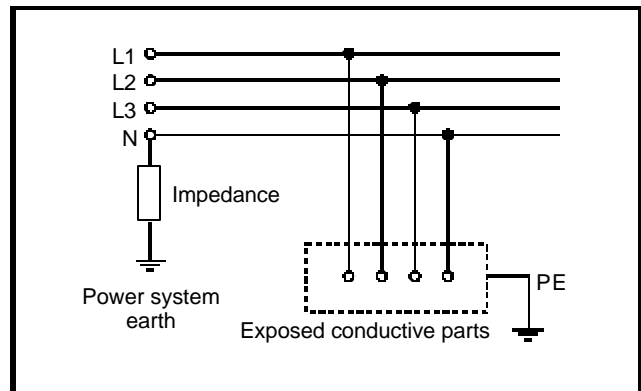

Example of IT power system



**Never remove the ground lead to the electrical cord and plug the system into a non-grounded outlet.** This is very dangerous and can lead to a severe, if not fatal, electrical shock. Always plug the system into a 3 prong grounded outlet.

If electrical power fluctuations, brown outs, or constant power outages are a problem in your area, an electrical line stabilizer, UPS (Uninterruptible Power Supply), or backup generator might be required. If installing any of these devices, make sure that they meet the electrical requirements of the laser system.

If there is any type of electrical problem present, please contact a locally licensed electrical contractor to correct the problem. If an incorrect electrical supply, voltage spike or surges damage the laser system, the damages **WILL NOT** be covered under warranty. **It is your responsibility to provide a suitable electrical supply.**



---

## Exhaust Requirements

To properly exhaust fumes and smoke from the laser engraving system during operation, it is necessary for you to provide a proper exhaust system. This system **MUST** be capable of supplying 250 CFM (cubic feet per minute) @ 6 inches of static pressure (water).



**Never operate the laser engraving system without a properly installed and operating exhaust system. Some materials when cut or engraved can produce fumes that are hazardous in concentrated amounts.**

The blower **MUST** be mounted on the **OUTSIDE** of the building either on the roof or on a cement pad next to the building possibly mounted on vibration dampers.

Rigid tubing should be used for 90% of the distance traveled. The tubing should be smooth walled and have as few 90 degree bends as possible. Two 45 degree bends have better airflow than one 90-degree bend. Use tubing with a diameter that matches the blower unit (usually 6 inches/1524 mm) and use a 6 inch (1524 mm) to 4 inch (1016 mm) reducer to couple the tubing down to 4 inches (1016 mm) to within a few feet from the laser system. Do not connect the rigid tubing directly to the laser system. Use a short piece of industrial grade, wire reinforced rubber tubing to connect the end of the gate, or rigid tubing, to the laser system. This will provide mobility and will dampen blower vibrations. Use only a few feet because it's spiral construction reduces airflow. Install a hose clamp on both ends of the hose to prevent leaks and to prevent the hose from slipping off. Finally, have the blower wired to a wall switch in the same room for easy ON/OFF control.

Also consider installing a gate to control airflow and to close off the exhaust from the outside environment when the laser is not in use. This is especially useful in colder climates where it can be damaging to the laser system to have cold air coming into it from the outside.

In order to meet the laser system's CFM requirements, a high-pressure, high static pressure rated, exhaust blower must be installed. This type of blower has self-cleaning blades and can maintain airflow even though restrictions are introduced. Length of exhaust pipe, exhaust pipe diameter, number of 90-degree angles, and other restrictions must be calculated when determining the correct exhaust blower unit. Installing an incorrect or undersized blower is not only unsafe, but it can also lead to premature and excessive wear and tear to the laser system.

**DO NOT** install forward incline, backward incline, in-line, or ventilator fans because these types of air handlers are inadequate and inappropriate for this type of installation. If your contractor has any questions concerning blower specifications or exhaust system requirements, please contact our Service Department directly before installation.

The following diagram shows a typical exhaust system layout. Use this as a guideline to proper exhaust system installation. Although these diagrams just serve as an example, we recommend installation of the exhaust system by a licensed contractor to meet safety and local code requirements as well as being able to calculate the correct size blower required for your particular installation.

## 2-4 Installation

The following diagram shows a typical exhaust system layout. Use these as a guideline to proper exhaust system installation. Although this diagram serves as an example, we recommend installation of the exhaust system by a licensed contractor to meet safety and local code requirements. Please contact a local air quality control specialist.

### ROOF MOUNT INSTALLATION EXAMPLE

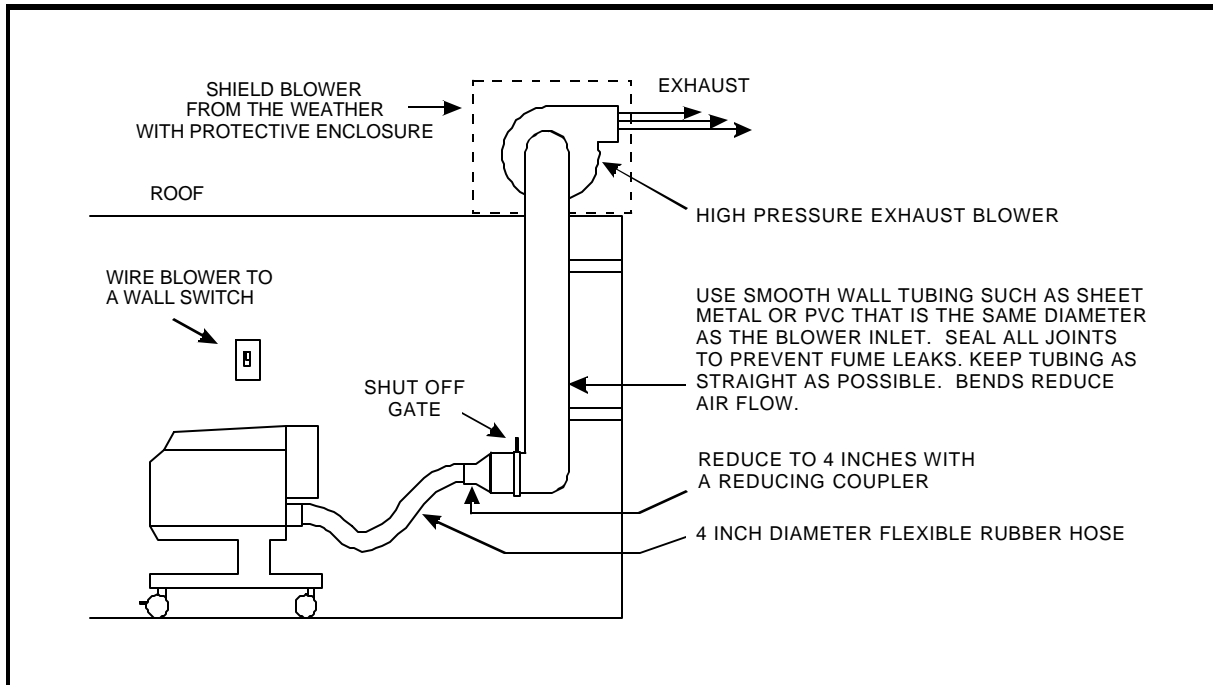

## Laser Cooling Requirements



Do not confine the back of the machine by surrounding it with furniture, shelving, backing it into a corner, etc. The backside of the laser system must be allowed to "Breathe" otherwise it can overheat the laser tube, power supply, and/or the CPU module. Overheating may cause serious and very costly damage to the laser system.

### Air Cooled Systems

This class of laser system use fans to keep the laser tube and electronics cooled during operation. Maintain the room temperature at the recommended ambient temperature range outlined previously in the Operating Environment section.

## Computer Requirements

The following is the **MINIMUM** required computer configuration. Using a faster computer with more capacity will increase efficiency and throughput. Although using a computer that does not meet our minimum recommendation might be acceptable to you, a faster computer will definitely pay for itself in a short amount of time.

- Pentium 300 MHz or equivalent
- 32 MB of RAM
- 2 Gigabyte hard drive or bigger
- 17 inch color VGA monitor
- 3.5" floppy disk drive
- CD-ROM Drive
- Mouse or other pointing device
- Microsoft Windows 95
- 600 DPI Optical Resolution Scanner

Remember that the laser system is an output device just like a printer is. The faster you can create graphics and manipulate your software, the faster you can download to the laser system to keep it producing.

## Software Suggestions

The following is a list of recommended software programs. We do not endorse any particular software program neither do we guarantee its full compatibility with the laser system. Please refer to the Appendices section on known bugs/anomalies related to these particular software programs, related versions, and ones that are not listed below.

### Graphics Programs

- CorelDraw
- Macromedia Freehand

### Bitmap / Scanning Software

- Adobe Photoshop
- Adobe Streamline - for raster to vector conversion

### CAD Software

- AutoCAD for Windows
- AutoCAD LT for Windows
- Autosketch for Windows
- DesignCAD for Windows

CAD users do not necessarily need Windows or Windows compatible programs. The laser system is compatible with any program that can output standard HPGL commands whether it is Windows based or not. Refer to the section on using DOS based CAD programs.

When a software company updates their version of their programs, it can sometimes cause conflicts with our printer driver. Our programmers constantly test new software programs and updated versions for compatibility. We will update our printer driver to address issues that we have control of. For bugs or problems with your software not related to the laser system, please contact the software manufacturer.

## Font Requirements

### True Type

We recommend using True Type fonts only. TrueType fonts are the most versatile and should be used whenever possible. They provide the best print quality and will print well at any size.

### PostScript

We do not recommend using PostScript fonts. The laser system is **NOT** a PostScript printer and therefore has no capability of printing PostScript fonts. Sometimes a PostScript font will print if you are running Adobe Type Manager (ATM). Adobe Type Manager converts PostScript fonts to bitmapped fonts before sending the information to our printer driver. Using ATM does not guarantee that the PostScript font will print properly therefore it is **NOT** recommended.

### Bitmap

Bitmapped fonts only print well when used at the specific point size they were designed for. This point size is usually indicated in the font name such as Times Roman 12. If a font is only available in bitmap form, you must print it at the size it was created for. Scaling the font larger will result in a more jagged looking character although scaling it smaller produces good results.

### Helpful Tip

If you are having any problems printing a font and you cannot figure out what is going on, select the font and “convert to curves” or “convert to paths” in your graphics software. This will convert the font into a bitmapped image and will print correctly to the laser system. Refer to your graphics software on how to convert fonts.

As you can see, we strongly recommend the use of True Type fonts only. Usually, most graphics programs, such as CorelDraw come with hundreds of fonts that you can install. For the average user there is more than enough to choose from.

## Making the Connections

Please use the parallel cable supplied with the system. It is a 6-foot high quality shielded cable that has a molded ferrite choke built in. If you use a printer cable other than the one provided, it will violate the laser systems FCC and CE rating and may also cause harmful interference when downloading files to the laser system.

Please make the following connections in the exact order described otherwise static electricity can damage the computer and/or the laser system’s electronics.

- Connect the laser systems power cord and the computers power cord to the electrical outlet(s). Do not turn on either unit at this time.

- Connect the laser system to the computer using the parallel port connection.

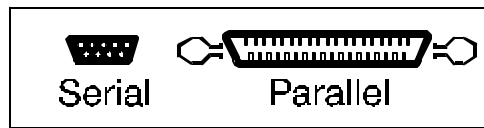

- Turn on your computer first and let it boot up.
- Turn on the laser system.

## Problem Prevention

The following are things that you **MUST NEVER** do:

**1) Never connect or disconnect the printer cable while either the computer or the laser system is powered ON.** Always power down both units and leave them plugged into the wall outlet when connecting or disconnecting the printer cable.

**2) Never connect the laser system through a manual switch type A/B switch box.** If connecting an additional laser system or other printer to the same computer, we recommend the installation of an additional parallel port into the computer. Using a switchbox can create electrical noise that can cause an engraving problem or can damage the laser system and/or the computer's electronics.

**3) Never use any device that is installed between the computers parallel port and the parallel port of the laser system such as a ZIP drive or parallel port CD-ROM drive.** This can not only damage the laser systems electronics but it usually will not work and will cause file transmission errors. Again, install an additional parallel port for other peripheral devices.

The following are things that you **MIGHT NEED** to do:

**1) Check your computers BIOS setting for your parallel port.** Make sure that it is set to either "ECP" or "Standard Parallel Port". **DO NOT SET IT TO "EPP" or "Bi-directional"**. The laser system does not support these modes. If your computer is set to an incorrect configuration, erroneous data will be sent to the laser system during printing. This can cause the system to lock up, print garbage information, or not print at all. For information on how to check or adjust your computer's BIOS setting, please refer to your computer's owner manual or call their technical support department.

**2) Change video drivers within Windows 95/98.** It is possible that your video card or your video driver is not 100% compatible with our laser systems printer driver. In that case, try using the standard VGA or SVGA driver that comes with Windows 95/98. A symptom of this would be some parts of your graphic not printing correctly such as pieces disappearing or colors that do not map to the laser systems printer driver correctly. Please report any video driver conflicts to our Technical Services Department.

**3) Reduce your computer's video hardware acceleration.** Many Pentium II based computers video hardware acceleration cannot be run at full speed due to video driver compatibility issues. To reduce the hardware acceleration in Windows 95/98, click on the "Start" menu, then "Settings", "Control Panel", "System", "Performance", "Graphics". Reduce the "Graphics Hardware Acceleration" one notch at a time, click "OK", then restart Windows and try printing again until the problem is resolved. A symptom of this problem is not being able to print a full field of graphics at higher resolutions of 500 DPI and 1000DPI. It may be able to print a few items, but if you try to print all of them, it may drop out and totally ignore the rest of the graphics. Another symptom would be the inability of the laser system to produce a "shoulder" when using the "3D Effects" setting in the driver. Instead of the engraving appearing "3D", the engraving appears the same as if the "3D Effects" option were not selected.

The following are things that you **MUST** do:

**1) Use only the IEEE1284 compliant parallel printer cable supplied with the laser system.** In very electrically noisy environments, there may be a problem with data transmission to the laser system. A symptom of this will be the laser system stopping in the middle of a printing a job. Everything freezes except the clock on the control panel continues to run. The only way to get the system going again is to turn it off then on.

**2) If using Corel 8.0, you must change a setting in its default configuration.** Corel 8.0 uses, as its default, the Pantone color, display palette. This causes a problem with our driver's power setting, color mapping ability. A symptom of this would be an incorrect power setting being downloaded to the laser. For example, if you draw an object using what you think is the color "Red", Corel 8.0 actually tells our printer driver that it is the color "Orange" and uses the laser power settings that you defined in the driver for the color "Orange". Obviously, this will not produce the results that you desire. To fix this problem, you must first start Corel 8.0. Start a new graphic then click on the "Tools" menu. Then click on "Options", double click on "Global", click on "Color Management". Now deselect "Calibrate Colors for Display" so that there is NO check mark in the box. Click on "OK" and watch your screen colors change immediately.

**3) Change a setting in one of CorelDraw's ini files.** If you are using any version of CorelDraw, you need to change the Fontrasterizer setting to "0" (zero). Corel's interpretation of fonts can sometimes be different than what Windows had intended the font to be. This is why we must turn off Corel's internal rasterizer and allow Windows to rasterize the fonts. A symptom would be fonts that print like black blocks. Another symptom would be that the font engraves scrambled when it is "Fitted to Path" and mirrored even though it looks good on screen. To learn how to change this setting go to Corel's help menu on screen and search for "Fontrasterizer" (without the quotes). It will tell you how to disable this setting.

**4) Use the CorelDraw color palette that is found on your laser system's printer driver disk.** If you do not know how to set up your color palette to match the printer driver's color mapping feature, you can load the file called ULS.CPL into your CorelDraw's configuration. This palette can be used in versions 4,5,6,7, and 8. Color palette setup is described in more detail in Section 3 of this manual.

**5) Set your line widths to the smallest possible size (in inches) to enable the laser system to vector.** In versions like Corel 4, you need to set the line width to .001 inches to

enable the laser system to vector that line. In Corel 8, you need to set it to .0005 inches for it to vector. Both of these settings are the smallest line widths that those versions can display.

## SECTION 3

# The Printer Driver

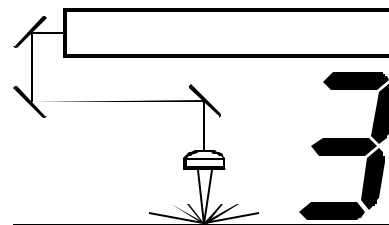

This section describes how the computer controls the laser system through the printer driver. It defines some very important terms that you need to know in order to operate the system correctly so please read it thoroughly.

## How the Computer Controls the Laser System

The laser system is a unique type of output device. Let's call it a very sophisticated printer/plotter. A regular laser printer is a "raster" based output device and so is a bubble jet, ink jet, and a dot matrix printer. A plotter is a "vector" based output device. The difference is how characters and other graphics are formed. To explain what "raster" and "vector" are, let us use the example of trying to print the letter "T". A raster printer will make a back-and-forth motion to create the character whereas a vector plotter will follow the path of the outline of the character.

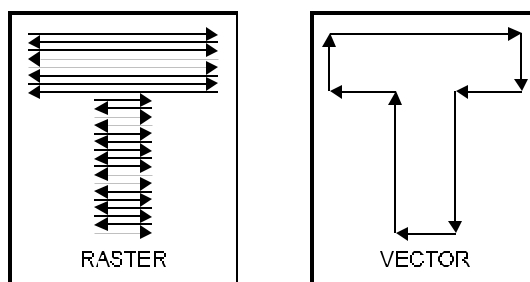

The laser system can actually raster the image, vector the image, or do both raster and vector motions. The laser systems printer driver works directly with your software program to send the correct image to the laser system. We will explain later on in this section about how this works but for right now, we want you to understand this simple concept behind how the computer controls the laser system:

The laser system is an output device just like a printer or plotter is. After the graphic is created on your computer system, you print the graphic the same way you would print to a laser printer or plot to a plotter. This information then gets sent down to the laser system through the parallel cable and is stored in the laser systems RAM memory. Once the file is in memory, press the "Start" button on the control panel to begin processing. The only real difference between how a laser printer or a plotter works compared to the laser system is that the laser systems printer driver also has controls on how much laser power as well as motion system speed is applied. Obviously, there are many more differences between the laser system and other output devices, but as long as the basics are clear, we can continue to learn about how the system works.



# Installing the Windows 95/98 Printer Driver

Installation of the Printer Driver for Windows 95/98 will allow your software program to interface with the laser system. This driver is installed the same way as most other Windows 95/98 printer drivers and a simple step-by-step installation procedure is outlined below. Complete understanding of how Windows 95/98 works is essential to the operation of the laser system. Please consult the Windows 95/98 owner's manual on its installation, use, and operation before continuing.

1. Power ON your PC.
2. From the Task Bar click "Start".
3. Point the mouse to the "Settings" icon, and then click the "Printers" icon.
4. Double-click on the "Add Printer" icon.
5. When the "Add Printer Wizard" appears click "Next".
6. Click "Local Printer" and click "Next".
7. When the "Manufacturer" and "Printers" menu list appears click "Have Disk" (Do not look for the printer in the menu).
8. Insert the driver disk.
9. Make sure the dialog box matches the floppy drive you are using: "A:\\" or "B:\\".
10. Click on "OK".
11. When the list of "Printers" appears, click the model that you have. If you are unsure about which model you have, look on the tag located on the back of the laser system.
12. **DO NOT** click on "Have Disk" again, click on "Next".
13. Click the port your laser system is connected to and click on "Next".
14. **NEVER** rename the printer driver, as this will make it inoperable.
15. Choose if you would like to set it as your default printer and click on "Next".
16. Select "No" when it asks to print a test page, and then click on "Finish".
17. The "Printers" dialog box will reappear. Click once on the driver then click on "File" and drag the mouse to "Properties".
18. The driver settings screen will appear. Click on the different tabs to get familiar with all of the controls. Click on "OK".
19. Driver installation is now complete. Store your driver disk in a safe place.

## Driver Controls

The Printer Driver for Windows 95/98 (driver for short) has the appearance of other Windows 95/98 printer drivers. A thorough understanding of how Windows 95/98 operates is essential to operating the driver's controls. Please refer to your Windows 95/98 manual or online help screen on how to install, operate, and troubleshoot Windows 95/98.

### General, Details, and Sharing Tabs

The tabs "General", "Details", and "Sharing" are tabs that Windows has control of and are present in all Windows 95/98 Drivers. For information on how to use the controls located in these tabs, please refer to your Windows 95/98 manual or online help screens.

### Laser Settings Tab

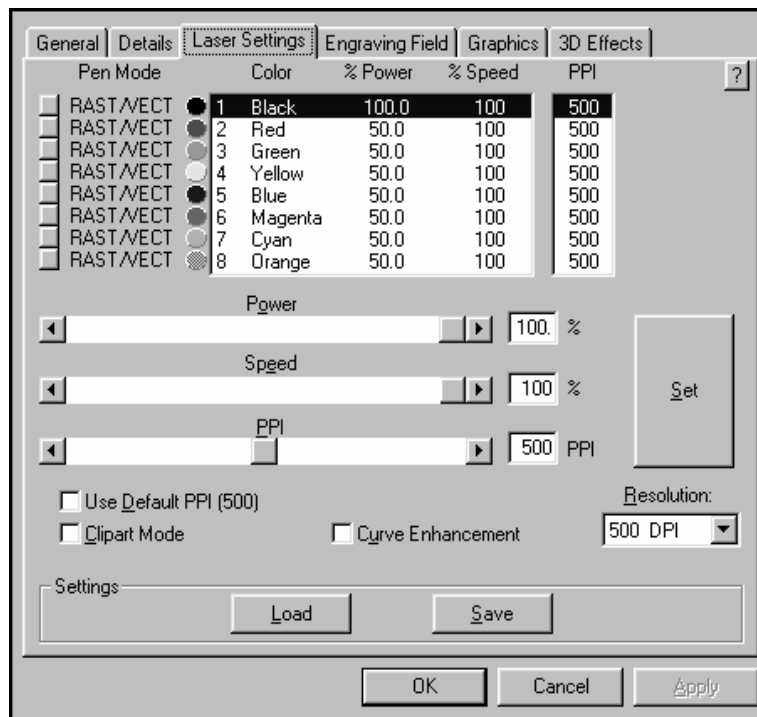

The settings in this tab are primarily used to adjust the Power, Speed, and PPI of the different driver colors as well as setting the overall printing resolution.

**NOTE:** When the following sections refer to turning a switch ON, this means clicking in the box next to the driver selection desired and a check mark will appear. Turning a switch OFF signifies removing the check mark from the box by clicking on it again. To change the Power, Speed, and PPI of a color, position the mouse arrow on the color and click once with the left mouse button. This will highlight the color and allow changing of the settings by using the scroll bars or highlighting out and typing in each setting. It is possible to set one color at a time or click on additional colors to set more than one at a time.

### Color

The colors in the driver allow you to assign different laser settings and modes to your multi-colored drawn artwork. This enables you to control the depth of the burn as well as different visual effects to your material. You can assign settings for up to eight (8) **DRAWN** colors. These colors do not apply to bitmapped images, only **DRAWN** colors in your graphics program will be mapped to the different power settings that you define. Bitmapped colors, shades of gray, or black and white bitmapped images are handled differently by the driver and are all mapped to the "Black" color. Those images must be halftoned to produce the image. Please refer to the "Graphics" tab section for a more detailed explanation.

### Pen Mode

"RAST/VECT" will raster graphics for the selected pen color, and automatically switch to vector cutting mode for very thin lines. This mode is recommended.

"RAST" will only raster graphics for the selected pen color. There will be **NO** cutting lines for this color. This mode may increase the printing time slightly.

"VECT" mode will **ONLY** vector cut lines for this color. In order for lines to vector cut, they should be set as thin as possible in your application program. It will **NOT** do any raster of this color at all.

"SKIP" mode will entirely skip raster and vector artwork drawn in this color. If you assign "SKIP" to the color "Black", then bitmapped images will NOT print at all.

### Power Setting

Laser power is controlled by assigning the percentage of power from 0 - 100% to each color used in the graphic drawing. Since the laser is proportionally pulsed, this percentage represents how long the laser remains on for each laser pulse fired. Basically, the power setting is directly related to how deep the engraving will be. The Power setting is linear meaning that 100% power will engrave or cut twice as deep as 50% power.

### Speed Setting

This setting controls how fast the motion system moves in a percentage of the maximum speed of the laser engraver. The actual time that an object takes to engrave or cut is entirely dependent on the size of the graphic. Power and speed work together in determining how deep the engraving will be. Higher power settings and slower speeds will produce deeper engraving or cutting. You might notice that on small objects, engraving or cutting at a faster speed as opposed to a slower speed might not produce a faster engraving time. The time it takes to engrave or cut can be related to the size of the graphic and the mechanical ability of the engraver to achieve the speed that you have selected. If the laser system determines that it cannot achieve the speed that you have selected, for that size graphic, it will automatically adjust its speed internally, to the maximum speed it can achieve. This is visually evident when cutting curves or circles as opposed to straight lines, and you see the motion system automatically slow down. Proportional pulsing of the laser will ensure that there is no difference in the depth of cut from straight lines to curves.

**PPI**

PPI stands for laser pulses per inch. This setting determines how many laser pulses, per linear inch, the laser system will fire. Again, since the laser system is proportionally pulsed, all pulses will fire equally spaced from one to the next regardless of changes in Speed, Power, acceleration, deceleration, or the cutting of curves. For example, when setting the PPI to 500 and using a standard lens that has a laser spot size of five thousandths of an inch (.005"), significant pulse overlap will occur. The laser system fires a laser pulse and moves over two thousandths of an inch (that is 1 inch divided by 500). It then fires the next pulse and so on, overlapping the pulses significantly. Lines are formed by pulsing the laser pulses so close together and slightly overlapping each other that it appears to be a continuous line. Dot matrix printers work the same way except the laser system uses laser pulses instead of ink dots. When engraving, it is advisable to use a PPI setting of 500 or higher. If using less, the image resolution of the engraving is reduced. For cutting, a PPI of 150 and above can be used. Using less than 150 will result in the pulses being spread so far apart that they will not touch one another. This is a good example on how to perforate paper. Increasing or decreasing the PPI setting has absolutely no effect on engraving speed. The laser must either fire more quickly or slowly. Experiment with using different PPI settings on some scrap material when cutting or engraving and note the results.

**Set**

This button must be pressed after adjusting the Power, Speed, and PPI settings in order for these changes to take effect. If forgetting to click on "Set", and clicking on the "OK" button instead, the settings will go back to the previous ones and will engrave the object with the incorrect settings.

**Use Default PPI (500)**

Turning this switch OFF will permit the changing of the PPI settings. If the switch is turned ON, 500 PPI will appear in all of the colors and will be colored gray. Since 500 PPI is the setting that is used most often, this control sets the PPI to 500 automatically and does not allow change unless the "Use Default PPI (500)" switch is turned back OFF.

**Resolution**

This setting is the image resolution of the engraving in DPI or dots per inch. There are six DPI settings to choose from 1000, 500, 333, 250, 200 and DRAFT. The resolution can also be referred to as the vertical lines per inch or fill spacing. This is how many raster strokes per vertical inch of travel that the motion system steps down to produce the engraving. Higher resolutions will produce cleaner and deeper engraving but take longer. Lower resolutions produce a coarser and shallower image but are quicker to engrave. Experiment with the different settings and note the results.

### Clipart Mode

This switch **simulates laser printer output** and is very useful if using a drawing with many colors, shades of gray, or many outlines. It is recommended to turn this switch ON when using **DRAWN** clipart because there may be some underlying cutting lines hiding behind some filled areas. Having this switch ON gives a what-you-see-is-what-you-get output very similar to laser printer output. The entire drawing will be raster engraved, including all outlines, and only one power level will be used which is "Black". The color change ability of the driver is essentially turned off and all colors are engraved as different shades of gray. The laser system represents different shades of gray by producing a halftone pattern when engraving. The halftone pattern is based upon the "Resolution" setting of the driver the same way grayscale bitmaps are interpreted. Since clipart images use a wide variety of colors, shades, and outlines, the only effective way of engraving these images is to have this switch turned ON. Clipart mode also provides greater compatibility with Windows software that do not work well with vector devices such as the laser system. **Do not use this mode when printing photographs or bitmapped images.**

### Curve Enhancement

This feature makes vector engraving or cutting lines smoother and less jagged. It will **NOT** necessarily make the process faster, **ONLY** higher quality. Experiment with this feature on and off and note the results. **CAUTION: With the feature ON, the "Resume" button on the laser systems control panel, has the same effect as the "Start" button. This means that if you "Pause" and then try to "Resume" the job, the job will start over from the beginning. DO NOT use this option if you need to "Pause" and "Resume" within a job.**

### Save

A unique feature of the driver is being able to store all of the driver' settings in a file. By clicking on "Save", a pop-up "Save Engraving Setup" dialog box allows you to enter in a file name for all of the drivers settings. All settings will be stored in a file that has a ". LAS" extension. **DO NOT** rename the extension because the driver will not recognize the file as a settings file if it does not have the ".LAS" extension. These files can be stored in any directory and you can have as many setting files as your hard drive can hold.

### Load

To recall settings that you have previously saved, click on the "Load" button and choose the file with the settings that you would like load.

## Engraving Field Tab

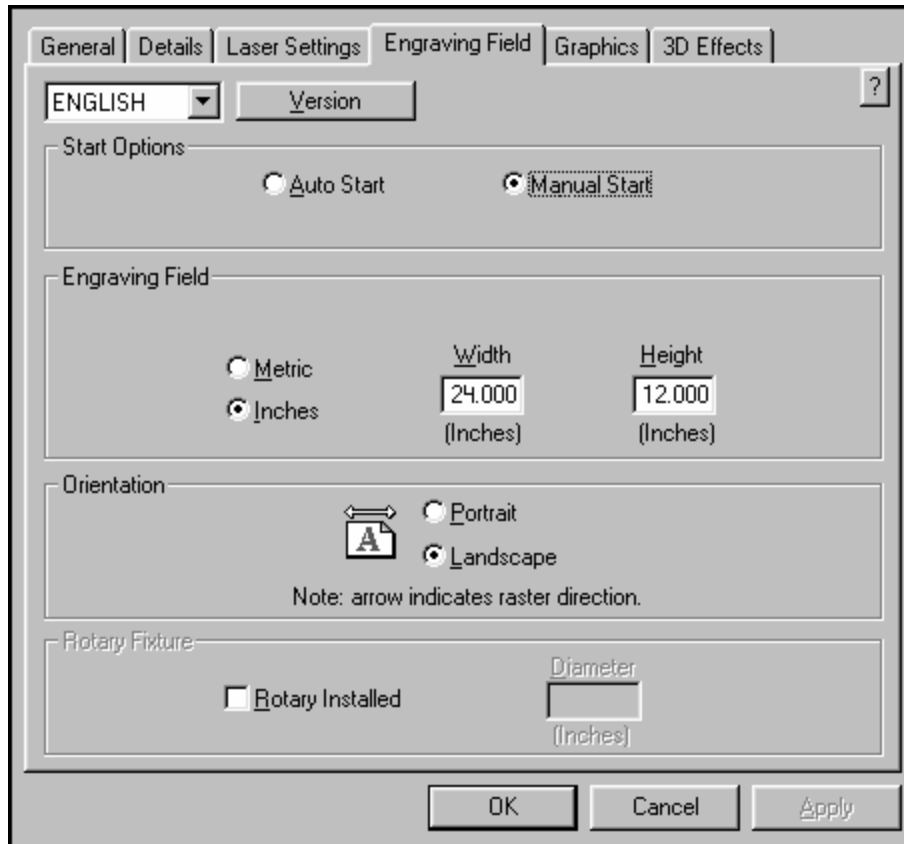

### Language

Select from many different languages in this drop down list. Some language changes will not take effect until the printer control panel is closed and then re-opened.

### Version

Clicking on the "Version" button causes the "Version" pop-up dialog box to appear. This has information on the current driver version number as well as the driver's copyright notice.

### ?

This selection, in upper right hand corner of all of tabs, bring you into the drivers online help screens.

### Start Options

Choose from either **Auto Start** or **Manual Start**.

**Auto Start** causes the laser system to start engraving without having to push the “Start” button on the control panel. In order for this option to work, the laser system must be set to the “One File Memory” mode. Refer to the “System Operation” section on how to set up the laser system in this mode. **Before using this option, please ensure that your exhaust system is turned on, your material is loaded into the machine and it is properly focused.** The system will start automatically as soon as the first bit of information enters the laser system from the computer without the operator having to press the “Start” button on the control panel of the laser system. Use extreme caution when using this function because there will be very little time to react and get over to the laser system once you click on “OK” in the driver.

**Manual Start** is the normal mode of operation of the laser system. The laser system will not start until the entire file enters into the laser system and the operator pushes the “Start” button on the control panel.

### Engraving Field

Input here lets the driver know what page size is being used in your graphics software.

**Width and Height** is the page size that you enter here to match the page size in your software program **EXACTLY** otherwise no output, partial output, or misalignment of the graphic will occur. It is up to the operator to enter in the correct settings. Select the **Metric** box if metric units are desired.

**Orientation** determines the raster direction of travel and **MUST** match your software programs Orientation **EXACTLY**. The Landscape mode is the normal mode of operation and causes the laser system to raster in the left and right direction. Portrait mode causes the laser system to raster from the front to the back of the laser system.

### Rotary Fixture

It is only necessary to use this selection if the optional Rotary Fixture has been purchased. Refer to the instructions provided with this option. Do not attempt to use this until you have read the rest of this manual. There is important information about the operation of the laser system that must be read and understood before operating the Rotary Fixture.

## Graphics Tab

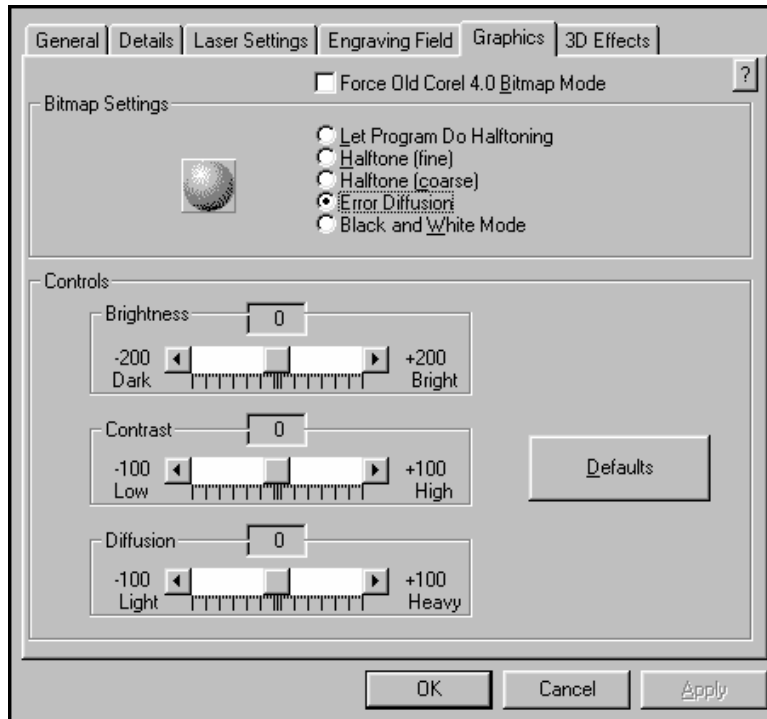

The **Graphics Tab** is used when printing non-black and white bitmaps and multicolored clipart images. Since the laser system really acts like a black and white printer (laser ON is considered black and laser OFF is considered white), grayscale or color photographs (bitmaps), as well as multicolored clipart images get turned into dithered images when reproduced by the laser system. This process is very similar to how newspaper photographs as well as laser printer photographs are printed. Since the laser system is a black and white printer, all grayscale or color bitmaps must be converted into a 1-bit “halftoned” black and white image. Either your software program or the laser system printer driver must perform this conversion otherwise the image will not print correctly or not at all. These driver selections enable the driver to perform the conversion but allows you to choose between the different halftoning methods available.

If you do not understand the terms “Halftone”, “Dither”, “Grayscale”, or “Bitmap”, please refer to the help section in your scanning software, graphics program, or Windows. We will offer a brief explanation in the following paragraphs.

### Force Old Corel 4.0 Bitmap Mode

Use this option **ONLY** if you are printing a grayscale or color bitmap directly from Corel 4, otherwise leave it OFF. This will cause the laser system to engrave a halftone pattern for your bitmap. The halftone pattern engraved is based on your “Resolution” choice in the driver. Please refer to the “Halftone Chart” on the following page. This allows the driver to be used as it was in the previous driver version. We just left it in there for you old timers.



RESOLUTION	ANGLE	SHAPE	LINES PER INCH
1000	45 DEGREES	ROUND	180
500	45 DEGREES	ROUND	90
333	45 DEGREES	ROUND	60
250	45 DEGREES	ROUND	45
200	45 DEGREES	ROUND	36

**Corel 4.0 Halftone Chart**

**Bitmap Settings**

Select one of these options ONLY if you are printing grayscale or color bitmaps from programs OTHER than Corel 4.

**Let Program Do Halftoning** allows your software program to create its own halftone pattern instead of using the driver's patterns. Check with your software's help section on whether or not your program has this capability.

Halftoned images have a fixed number of black dots that represent grayscale or color bitmaps. The optical illusion of shades of gray appears due to the size of the black dots. If the black dots are larger in a part of your image, it will appear to be darker. If the size of your black dots are smaller, then that part of your image appears to be lighter.

**Halftone (fine)** engraves the halftoned image based on the following chart:

RESOLUTION	ANGLE	SHAPE	LINES PER INCH
1000	45 DEGREES	ROUND	180
500	45 DEGREES	ROUND	90
333	45 DEGREES	ROUND	60
250	45 DEGREES	ROUND	45
200	45 DEGREES	ROUND	36

**Halftone (coarse)** engraves the halftoned image based on the following chart:

RESOLUTION	ANGLE	SHAPE	LINES PER INCH
1000	45 DEGREES	ROUND	90
500	45 DEGREES	ROUND	45
333	45 DEGREES	ROUND	30
250	45 DEGREES	ROUND	22
200	45 DEGREES	ROUND	18

**Error Diffusion** scatters the pixels in a random pattern to represent shading. This randomized dither pattern is unlike the fixed pattern of a “Halftone” screen and can be adjusted. Unlike halftoning, Error Diffusion represents the grayscale or colored bitmapped image by adjusting the number of black dots as opposed to the size of the black dots. Selecting this option enables the **Error Diffusion Controls**.

**Black and White Mode** thresholds the image at 50% black. Each pixel that is greater than 50% black will be converted into white and each pixel that is 50% black or less will be converted into black. This effect is very similar to trying to duplicate a photograph using a photocopy machine.

### **Error Diffusion Controls**

When you select **Error Diffusion**, this section becomes enabled allowing you to adjust 3 settings: Brightness, Contrast, and Diffusion.

**Brightness** is similar to the brightness control in most photo editing software. Adjusting the slider to the “Bright” side brightens each pixel in the bitmap one shade of gray for each increment. Adjusting the slider to the “Dark” side darkens each pixel in the bitmap one shade of gray for each decrement.

**Contrast** is also similar to the contrast control in most photo editing software. Adjusting the slider to the “High” side increases the contrast of the image by making the lighter colors brighter and the darker colors darker. This decreases the amount of different gray colors in the image. Sliding it to the “Low” side decreases the contrast of the image by making the lighter colors darker and the darker colors lighter. This increases the amount of different gray colors up to a maximum of 256 shades.

**Diffusion** controls the amount of graininess or “noise” level. Adjusting the slider to the “Heavy” side increases the noise level thus causing the image to appear more “noisy”. Sliding it to the “Light” side reduces the noise level and causes the image to appear more solid and have less “noise”.

### ***Helpful Tip***

Engraving photographs, grayscale, or color bitmaps with a laser system requires some practice and a bit of trial and error to achieve perfection. It also requires some knowledge of bitmap editing software. Photographs will visually appear different on one material as opposed to another material even if you use the same “Laser Power” and/or “Dither Type” settings. As a rule of thumb, use the **Halftone (fine)** or **Diffusion** pattern on harder materials such as marble, anodized aluminum or Microsurfaced engraver's plastic. Use the **Halftone (coarse)** pattern for softer materials such as wood or materials that you intend on engraving very deeply.

There is much more to laser engraving photographs and clipart images than stated above. Please refer to the section on “Bitmapped Images” for a more thorough description of how to use, manipulate, and engrave these types of images.

The following images are examples of the output of the different **Dither Types**.

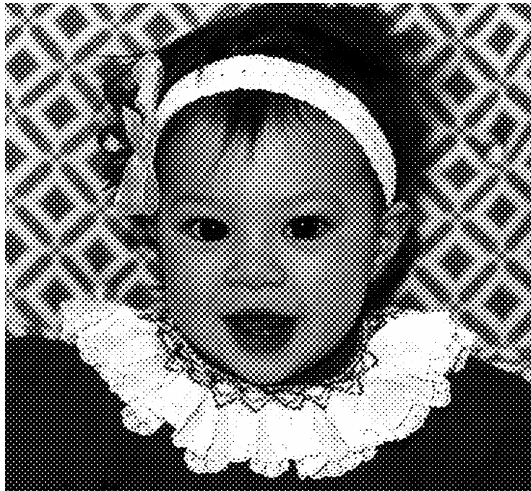

Halftone



Diffusion Dither

### 3D Effects Tab

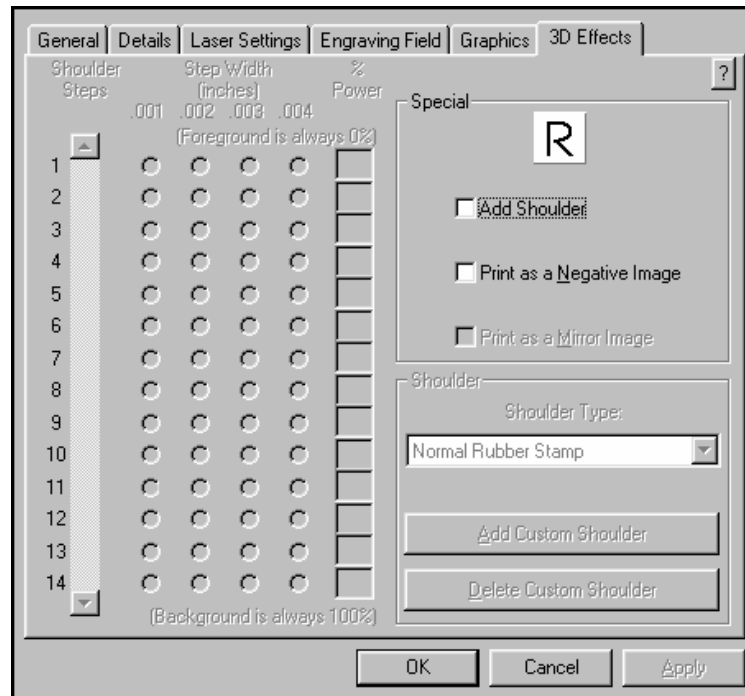

### 3D Effects

This option enables the laser system to raster engrave materials in a 3D fashion where the image appears to be “chiseled” or “sunken”. The beam appears to have engraved the material on an angle but in actuality it is a precise control of laser power that creates this appearance. It only has an effect on raster images and no effect on vectors. This option is also used to create rubber stamps as well as other types of marking devices. Here’s how it works:

Use the letter “T” as an example. Pretend to create a “T” in your graphics program. Fill it with black and make sure it does not have an outline. If the “3D Effects” option is activated and the “T” is printed to the laser system, the driver turns the “T” into a 3D object that has defined steps of laser power. The final image looks as if it is chiseled into the material.

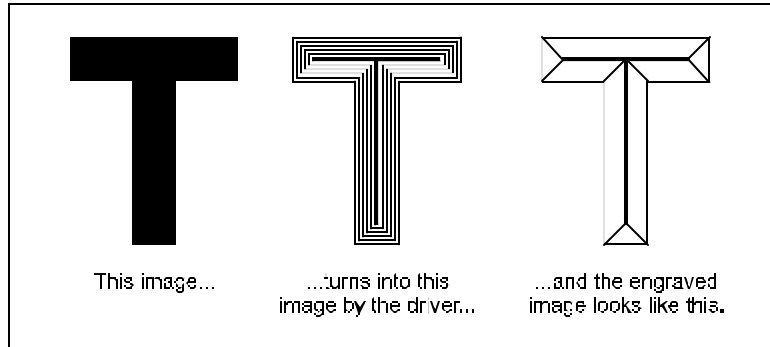

**Special**

Choose from three (3) special effects.

**Add Shoulder** activates the 3D Effects feature. This adds a shoulder to all raster graphic objects within the engraving area but does not effect vectors

**Print as a Negative Image** inverts the **ENTIRE PAGE** of graphics and turns any white object into black and any black object into white. Since this option creates a negative image for the **ENTIRE PAGE**, the raster engraved object will be “raised” instead of “sunken” because the entire background will have been engraved and the object will remain standing up. This is very useful for engraving a full sheet of rubber stamps.

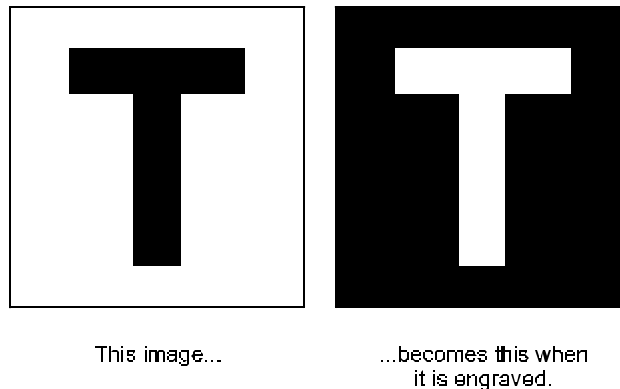

**Print as a Mirror Image** mirrors the **ENTIRE PAGE** from left to right (horizontally). Will not mirror individual objects or selections. Very useful for doing rubber stamps because the objects that are on screen are readable, but when they engrave, they come out mirrored.

## 3-14 The Printer Driver

---

### Shoulder

Choose from one of the preset options by clicking the down arrow in the “Shoulder Type” dropdown list and selecting the type of shoulder you desire. These preset options are not adjustable but you can create your own custom shoulder if you desire.

### Add Custom Shoulder

This button allows you to create up to 10 of your own custom shoulders. Select a preset shoulder option that most closely resembles the shoulder that you would like to start with, then click on “Add Custom Shoulder”. You will see “Custom Shoulder #1” appears in the “Shoulder Type” dropdown list and the left side of the dialog box will enable. There are three adjustments, the number of steps, the distance between steps, and the power setting for each step.

Before you set the parameters, you must first understand how each parameter works. In the normal engraving mode, the laser beam engraves virtually straight down into the material. In the 3D Effects mode, the laser beam is controlled in such a manner that it steps the power settings in order to create a shouldered engraving.

### SIDE VIEW OF THE ENGRAVED MATERIAL

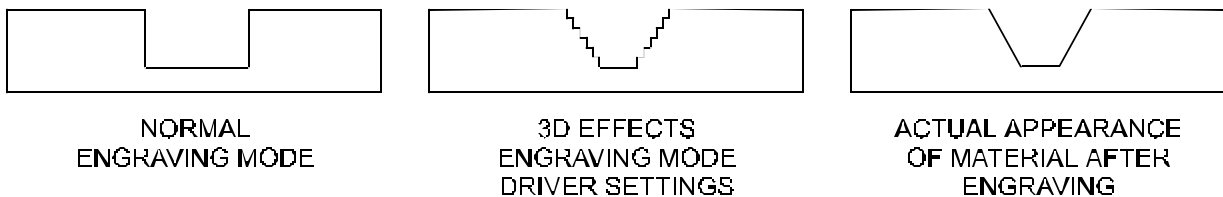

From the diagram above, you can see that there were 7 steps used to create this shoulder. The surface of the material is considered the first step and the bottom of the engraving is considered the last step. Let's use 7 steps as an example. You can define as many as 14 steps. The first or the last steps are not definable because they are fixed at a power setting of 0% and 100% respectively. You can only define the parameters for the steps in between the first and last steps. By adjusting the power setting for each step, the width in (.001) inches for each step, and the number of steps, different shoulder profiles can be created.

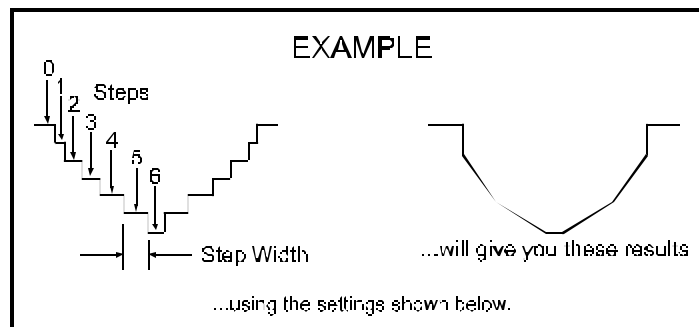

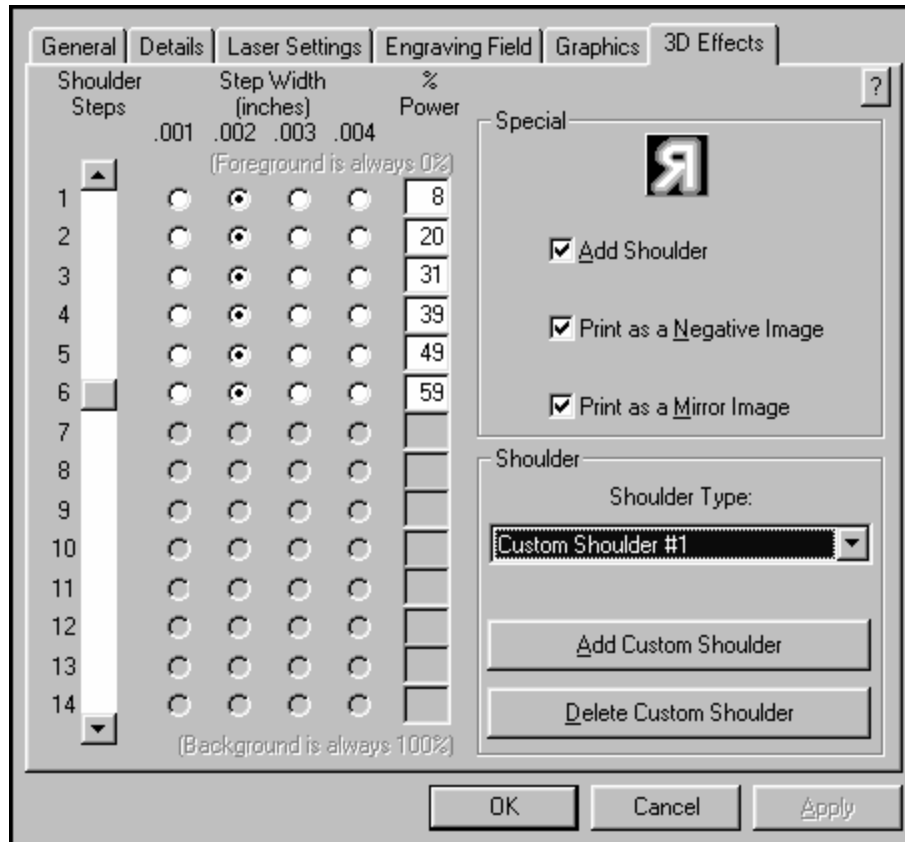

The above settings are just an example to show you how to use the controls. This example might not achieve the exact stated results on your particular material. This is why the driver has custom settings available for you to control.

### Delete Custom Shoulder

Click on the custom shoulder that you want to delete and then click on this button to permanently delete it.



Deleted custom shoulder profiles cannot be restored so make sure that you absolutely want to delete it before clicking on this button.

---

## SECTION 4

# Graphics Software

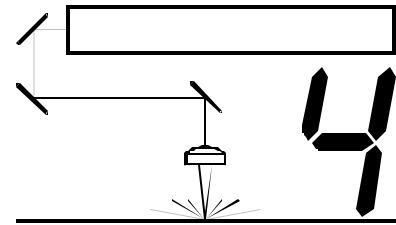

Choosing the right graphics software program to run the laser system is essential for maximum usage and control of the laser system. Not all software can be used to run the laser system because many have limitations. Because you may be using a word processing software to output to your laser printer does not mean you should use it to output to your laser engraving system. Setting up you software correctly is essential to running the laser system properly.

## Software Setup

There are many software programs that you can purchase off-the-shelf that will work with the laser system. Some of them can access more features of the laser system than others. Whichever program you choose, it must be set up to work with the laser system otherwise unexpected results may occur. Use the following guidelines when configuring your software program.

### Page Setup

To properly generate and position artwork, most graphics software will permit the customization of the page size and orientation. Set the page orientation, in the graphics software to Landscape, and the page size to a horizontal length of 24 inches (609.6 mm) and vertical height of 12 inches (304.8 mm). The driver's orientation and page size **MUST** then be set to match these specifications **EXACTLY**, otherwise the artwork may not print correctly. When setting page orientation and driver orientation to Landscape mode, the laser system will operate in the horizontal direction, left to right. If page orientation and driver orientation is set to Portrait mode, the laser system will operate in the vertical direction, front to back. The laser system is designed to operate best in the Landscape mode and this orientation is highly recommended. The page size may also be reduced to match the size of the engraving material, but remember to adjust the page size in the driver's to correspond to the graphics software's page size. Note that in production situations it is often more efficient to leave the page size at its maximum page size and engrave or cut more than one object at a time. This is accomplished by duplicating the image on screen as many times as necessary to fill up the entire page.

### Ruler Setup

Usually the graphics software will provide on-screen rulers, which can be configured to match the rulers in the laser system. Using rulers in the software and matching them with the ones provided in the laser system gives the ability to correctly align the graphic on the screen with the material in the laser system. For now, consider that the laser system's origin is fixed in the upper left corner of the engraving area and cannot be altered. Later on you will learn how to relocate the origin. But for right now, change the ruler position on screen to match the laser system with the origin (0,0) in the upper left corner.

## 4-2 Graphics Software

---

It is also possible to use a page size smaller than the maximum engraving area. For example, if an 8 inch (203.2 mm) x 10 inch (254 mm) page size is desired, set this page size in the graphics software as well as in the driver. The laser system will automatically move the engraving area to the origin so place the object all the way up into the left hand corner against the rulers in the laser system.

### Power Control Through Color Selection

The laser system allows the use of 8 different colors to access 8 different power settings when cutting and engraving. This feature is controlled by the driver. When using this power change feature with driver, the colors that are used **MUST** exactly match the colors listed in the driver. The colors are black, red, green, yellow, blue, magenta, cyan, and orange. Some programs will provide these basic colors pre-defined and other programs may require the creation of each of the colors by defining them in CMYK percentages. **NOTE: To make it easy for you, we have supplied a CorelDraw (all versions compatible) color palette on your driver disk called ULS.pal. Load the palette from within CorelDraw and save it.** If you are using other software and need to mix your own colors, use the chart below to create them.

COLOR	CYAN	MAGENTA	YELLOW	BLACK
BLACK	0 %	0 %	0 %	100 %
RED	0 %	100 %	100 %	0 %
GREEN	100 %	0 %	100 %	0 %
YELLOW	0 %	0 %	100 %	0 %
BLUE	100 %	100 %	0 %	0 %
MAGENTA	0 %	100 %	0 %	0 %
CYAN	100 %	0 %	0 %	0 %
ORANGE	0 %	60 %	100 %	0 %

If using a color other than the exact colors listed above, the driver will attempt to match it to a color in the driver that it most closely resembles. The driver will then use that color's power setting and apply a halftone pattern to represent the original color's shade. For example, if using a color like pink to fill a rectangle, the driver takes a reading of the percentage of different colors used to create that color and will use the power setting assigned to one of the eight colors of the driver that it most closely resembles. It might be expected that the driver will use the power setting assigned to the color red but instead the driver may choose the magenta setting and halftone the rectangle as a representation of the pink color's lighter shade. To prevent the incorrect assignment of laser power, be sure to use the right colors. If using graphics with colors other than the eight listed above or to simplify the assignment of power settings, try using the Clipart Mode feature in the driver. This feature will cause the system to only use the power setting assigned to the color black and halftone all of the other colors.

### Outlines and Fills

The driver distinguishes between raster mode (engraving) and vector mode (cutting) by the type of graphic artwork being used. Basically, all graphics other than outlines of very thin line widths will be interpreted as engraved images and the raster mode will be used for output. If laser cutting is desired, set the line thickness of the lines that are drawn in the graphics software to .001 inches (.1 mm) or the smallest possible line thickness that is available.



The printer driver will interpret these objects as vectors and will cut them out providing that your software has the capability of vector output. Basically, all software programs have the ability to provide raster output. However, not all programs have the ability to provide vector output even if you set the line width to the smallest thickness possible. Check with Software Anomalies section in the back of this manual for software that can vector output.

The use of color fills or bitmaps will cause the laser system to engrave. The combination of engraving and cutting is available in most graphics software. We suggest that when combining engraving and cutting objects, use different colors for the fills and outlines since engraving requires different power settings than cutting objects. One thing to keep in mind when creating cutting objects is that if the outline thickness is set too thick, the driver might interpret the outline as a filled object and will engrave the outline instead of cutting. This might be desirable if engraving thick outlines is necessary. The outline thickness at which the driver will interpret cut lines as filled objects is dependent on the software used. Usually, any line thickness .008 inches (.2 mm) or greater will engrave. The only way to determine the cross over point for line thickness is to experiment with different line widths. Software programs that do not have outline capabilities definitely will not have the ability to cut.

### **Image Processing Order**

When cutting or engraving a graphic image, the laser system will perform all engraving first, then proceed to cutting. Engraving will proceed in the exact order of the colors listed in the driver. For example, all black filled objects will engrave first, then all red filled objects, then all green filled objects and so on. When all engraved objects have been completed, the laser system will proceed to cut any outlines present in the artwork. Unlike engraving, cutting will proceed in the order from which the outlines are drawn regardless of color. There are several different ways to control the order in which the outlines are cut. One way is to draw them in the exact order in which they need to be cut, but this is not always practical. Another way is to select the outline in the graphics software and “send it to the back”, behind the other objects, to cause the outline to be cut first. Bringing the outline “to the front” will cause that outline to cut last. A final way is to cut and paste each outline in the cutting order desired. This effectively works the same way as the two previous suggestions.

### **Overlapping Fills**

If the artwork created has overlapping filled areas, the driver will automatically filter these fills to prevent the overlapped area from being engraved twice. This is similar to color separation in the printing industry. The entire filled area of the object on top will be engraved and only the visible part of the underlying filled area will be engraved. The final result is a what-you-see-is-what-you-get output. In this way the color white can be used as an effective drawing tool. Since the laser system will not engrave the color white (this is the background color), it can be used to block out the undesired engraving areas of filled regions and/or bitmaps. However, you cannot use a white fill to cover an outline, the outline will vector cut even though you cannot see it on screen.

### **Overlapping Outlines**

The driver does not filter outlines that overlap each other. If placing one outline on top of another, both outlines will be cut by the laser system. This is a useful feature that will allow deeper cutting by passing the laser over a single outline path twice or more. To take advantage of this feature, duplicate the outline on top of itself.

### **Hidden Vector Lines in Artwork**

The driver does not automatically filter out outlines that are overlapped by engraved objects such as fills. If there are filled objects with some hidden outlines underneath, the laser system will then engrave out the fill and cut the hidden outline on top of the fill. This is a common occurrence when using pre-drawn clipart designed for laser printers. To prevent this from happening, turn on the Clipart Mode feature in the driver. This feature disables the cutting mode and converts all visible outlines to engraved objects and ignores all hidden outlines.

## Speed Optimizing

It is advantageous to engrave an object in its longest direction because total engraving time will be reduced when the motion system has to make fewer stops and starts. If the engraving object is longer than it is tall, a greater engraving speed can be achieved by rotating the graphic 90 degrees and placing the material in the laser system sideways. Be aware that some graphics programs do not allow the rotation of bitmaps. In this case, it may be necessary to use bitmap image processing software to first rotate the bitmap before importing the bitmap into the graphics program. If the artwork contains engraved objects of the same color with a great deal of space between them in the engraving direction, processing time can be longer since the laser must make long strokes to engrave both objects at the same time. To reduce engraving time in cases like these, use different colors for each of the objects but assign the same power setting to both colors. This will cause the laser to engrave one object at a time, skipping over all blank space, which in many cases will reduce engraving time. On the other hand, if the objects are relatively close together in the engraving direction, then leave them the same color because it will be quicker to engrave them both at the same time. Experiment with these techniques to optimize the speed of engraving.

## Bitmapped / Scanned Images

There are primarily three types of bitmaps available. They are monochrome (black and white), grayscale, and color. Bitmaps are patterns of dots (pixels) blended to form pictures. Scanning artwork into a computer through a scanner creates most bitmaps. Others are created by drawing them in a bitmap image processing program. The laser system can print all three types of bitmaps providing that either the driver or the bitmap image processing program converts the grayscale and/or color bitmaps into a monochrome bitmap. Essentially, the laser system is a monochromatic printer, either it fires the beam to burn a dot or it does not fire the beam to leave an empty dot on the material.

There are several different bitmap storage formats available: TIF, BMP, PCX, and others. We prefer to use the TIFF format because it is most widely used format. The format makes no difference to the laser system. The difference in formats involves how they are stored on your computer's hard disk. Bitmaps cannot be edited in most graphics software. Some basic functions such as cropping, scaling, or mirroring might be possible but it is usually necessary to use a bitmap image processing software to perform a dot by dot editing, rotation, or scaling of the bitmap.

### **Monochrome Bitmaps**

If you scan the image in monochrome (black and white) mode, set your scanner to at least 600 DPI. The higher the DPI, the smoother the image will be. Scanning monochrome images at 300 DPI is the minimum recommended resolution but scanning them at 600 DPI will provide a significant improvement in the image quality. Clean it up in your bitmap image processing program and save it to your hard disk. You can now either print the image directly from your bitmap image processing program, or import the bitmap into a graphics program and print it from there. Monochrome bitmaps are engraved in the same manner as black filled text. The black area will turn the laser on and the white area turns the laser off.

### **Grayscale Bitmaps**

When scanning image in the grayscale mode, you should scan the image at no more than 300 DPI. Scanning at a higher DPI does not improve image quality but it consumes more memory and will take longer to print. Grayscale images cannot be printed directly to the laser system. Since the laser system actually works like a black and white printer, grayscale images must be converted into a black and white images. To do this, either the driver will do it automatically or you can convert the grayscale image to a black and white image in your bitmap image processing program.

The two primary grayscale image conversion techniques are Halftone or Error Diffusion. The printer driver can print either one and it is selected in the driver under the "Graphics" tab. Please refer to the section on the printer driver for more details on how to set these parameters. Since the driver has a fixed method of conversion, you may want to experiment by using your bitmap image processing program to make the conversion. These software programs usually have more options for controlling the size, angle, shape, and the amount of black and white dots (pixels) created when converting the image. Experiment with all of the controls to see which looks the best. Big dots look good on some materials and small dots look better on others. Once the image is converted by your program, save it and either print it directly from that program or import it into your graphics program and print it from there. Essentially, a Halftone image and a Error Diffusion image are actually both monochrome images and can be treated as such. If you decide not convert the grayscale image to a monochrome image in your bitmap image editing program, then the driver will do it automatically and will use settings based on the Resolution settings in the driver. Again, refer to the driver controls section on more details about how to use the driver.

### **Color Bitmaps**

The driver handles color bitmaps the same as grayscale bitmaps. Since color bitmaps use more memory, they are unnecessary and are therefore **NOT** recommended. You can scan color photographs by using the grayscale mode or if it is already color, convert it to a monochrome bitmap in your bitmap image processing program.

## Encapsulated Postscript (EPS) Images

Bitmap images cannot be cut by the laser system only engraved. The only way to have the laser system cut out or vector a bitmap is to first convert it to a vector file format such as an EPS. Raster to vector conversion programs are available that trace the bitmap (this only works well with monochrome bitmaps) and creates a separate EPS vector file. These EPS files can then be imported into the graphics program and printed out from there. Since tracing programs have many adjustments, some practice with them is necessary to produce desirable results.

The laser system does not support Encapsulated PostScript (EPS) printing directly. EPS files can only be edited and printed if they are first imported into a graphics program. However, since EPS files support engraving and cutting objects, they are therefore useful for transferring artwork from one graphics program to another. Once an EPS file has been imported into a graphics program, the objects can be outlined, stretched, rotated, mirrored, filled with different colors, or anything else desired just as long as your graphics software can edit EPS images. Be careful when using EPS files in layout software as opposed to true graphics software. Layout software may allow the placement of EPS files in the artwork but may not actually import and convert the EPS file to a useful format for the printer driver and therefore may not print correctly. Please refer to your graphics software's documentation on whether or not it can edit and print EPS images to a non-Postscript printer.

## Postscript (PS) Images

The laser system is **NOT** a postscript device. This means that postscript fills, postscript textures, and especially **POSTSCRIPT FONTS WILL NOT** be able to print to the laser system. Sometimes using Adobe Type Manager (ATM) will allow some postscript fonts to print correctly but most of the time does not work properly.

### ***Helpful Tip***

If you are having any problems printing a font and you cannot figure out what is going on, select the font and "convert to curves" or "convert to paths" in your graphics software. This will convert the font into a bitmapped image and will print correctly to the laser system. Refer to your graphics software on how to convert fonts. However, postscript textures and postscript fills cannot be converted and will not print to the laser system.

## SECTION 5

# System Operation

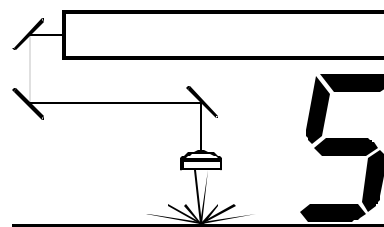

In this section you will learn how the laser system actually works and will familiarize you with laser system terminology. We will then start working with the control panel and learn how to get around in the menu system. Since there are many features in this laser system, the menu system may seem complicated at first, but once you start using it, you will find out that it is a very simple system to operate.

## How it Works

There are five (5) basic components that make up the laser system, the control panel, the CPU, the DC power supply, the laser tube assembly, and the motion system.

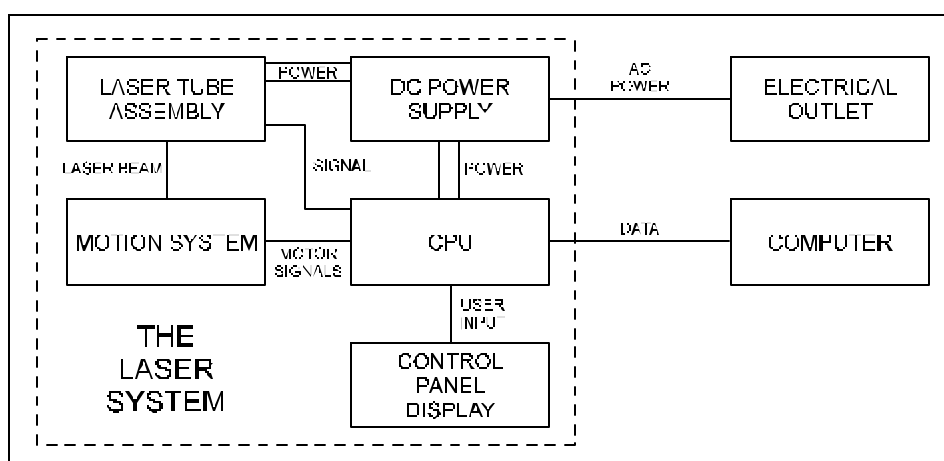

### DC Power Supply

The DC power supply converts the incoming AC electricity to 48 volts DC. This is used to power both the laser tube assembly and the CPU.

### CPU

The CPU is the “brains” of the system and controls everything. Located on the CPU are standard computer memory SIMMS. This is where incoming files, from the computer, are stored while the power is on. The CPU gets input from the computer and the control panel. It outputs precisely timed signals to fire the laser beam and to move the motion system simultaneously.

### Control Panel

This is where the operator controls the laser system. It is composed of tactile feel push buttons and a LCD display. From this panel, the operator can position the motion system, move around through the menu system in the LCD display, and run the laser system.

### Laser Tube Assembly

The laser tube assembly is a very sophisticated device. It is composed of a plasma tube filled with a special mixture of CO<sub>2</sub> and other gases, and RF (radio frequency) electronics. The function of the entire assembly is to turn electrical energy into concentrated light energy. The word LASER is an acronym for Light Amplified Stimulated Emission of Radiation.

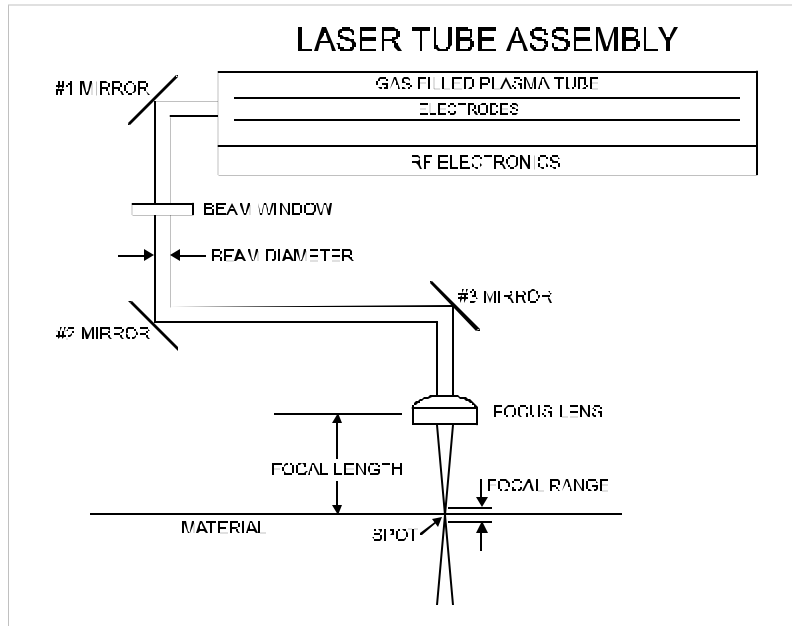

The laser tube assembly receives power from the 48VDC power supply and its "trigger signal" from the CPU. When the laser system is powered on and the trigger signal comes from the CPU, the RF electronics produce a high frequency AC signal across the electrodes located inside the plasma tube. This causes spontaneous photon emissions from the gas mixture that produces an invisible, infrared light beam at a frequency of 10.6 microns.

The laser beam exits the laser tube through its output optics, bounces off the #1 mirror, passes through the beam window, bounces off the #2 and #3 mirror, and finally passes through the focus lens. The #2 and #3 mirror and the focusing lens are all mounted to the motion system. The width of the laser beam as it exits the tube, called the "Beam Diameter", is about 4 mm. The focus lens focuses the beam into a very small spot whose "Spot Size" is dependent on the "Focal Length" of the lens. The "Focal Length" is the distance from about the center of the lens to the point where it converges the beam into the smallest spot possible. Using a standard 2 inch focal length lens, the spot size produced is approximately .005 inches.

The "Focal Range" of the lens, where the beam is considered to be "in focus", is equivalent to +/- 5% above and below the focus point. Shorter lenses produce a smaller spot size but also have a very narrow focal range. This means that it would only be useful for engraving very flat objects. The longer lenses have a much wider range of focus but also produce a larger spot size that would prohibit the engraving of fine detail. This can be related to trying to write small text with a wide, felt tip marker. There are pros and cons to the different lenses that are available for different applications. Please refer to the Appendices section on available lenses and their operating characteristics.

“Wattage” signifies the amount of heat energy that the laser light is producing over a period of time. Laser energy is measured with a laser power meter. Do not confuse the electrical wattage rating of a light bulb or a hair dryer with the wattage rating of the laser system. They are two different types of measurements.

### Motion System

The motion system consists of the mechanically moving parts of the laser system. It is made up of rails, motors, bearings, belts, mirrors, a lens, and other parts. There are two directions of motion, left and right is called the “X” direction and front to back is called the “Y” direction.

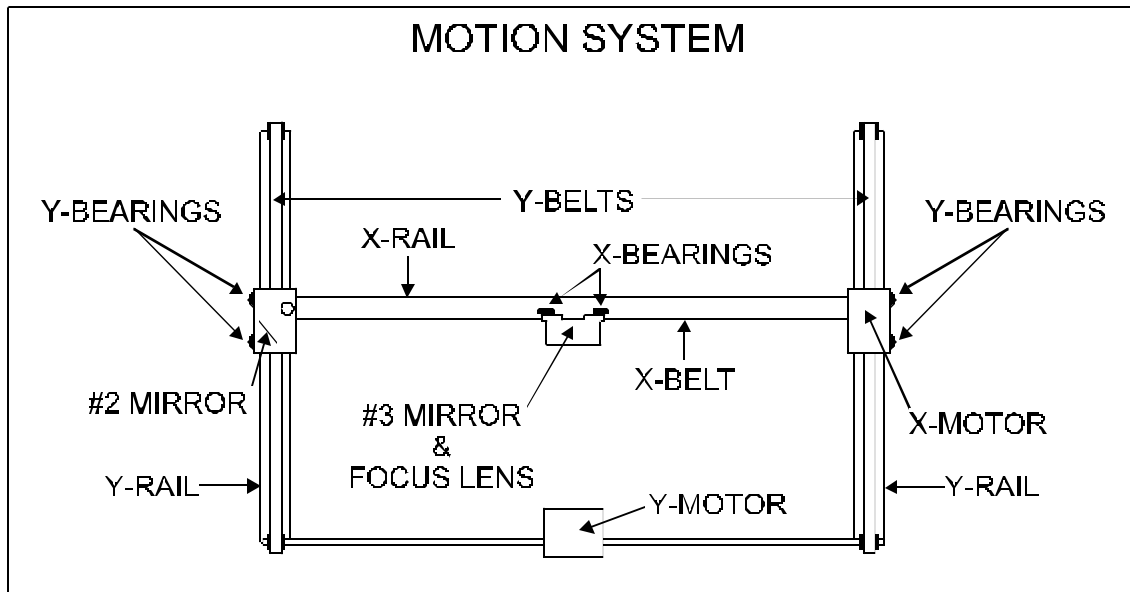

The CPU controls the movement of the motors, which moves the mirrors and focus lens across the engraving area and over the material. At the same time, it is synchronizing the laser pulses with the position of the focus lens. It is this precise positioning and timing of the laser pulses that produces the highest quality and fastest speed of engraving.

In summary, the five (5) components work together to take the graphic image that is downloaded to the laser system from your computer and burn it into the material located on the engraving table inside of the laser system.

## The Control Panel

The control panel on the laser system provides easy access to all of the controls necessary for cutting and engraving operations. The control panel consists of a liquid crystal display (LCD), indicator lights, and selection buttons. The following section will describe, in detail, how to maneuver through the menu system and the significance of each item in the control panel.

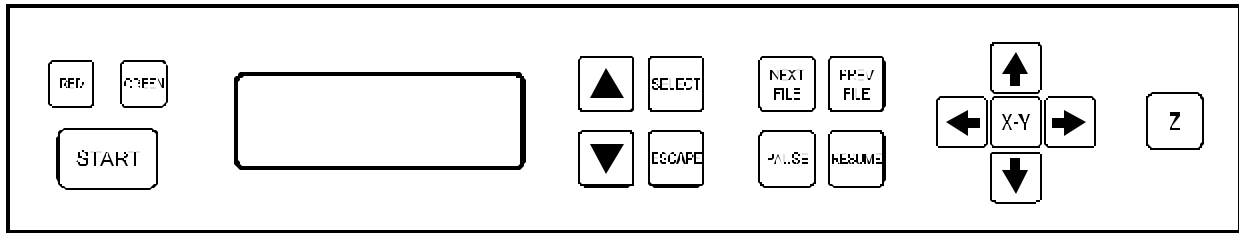

### The Liquid Crystal Display (LCD)

The LCD is a four line display that displays the menus that control the laser system. It is a backlit type of display that enhances visibility even under low light environments.

When the laser system is powered on, the laser system will perform a series of routines. "INITIALIZING" will display until the motion system and electronics have finished their routines. When completed, the display will then read "READY", signifying that the laser system is ready to accept files.



**DO NOT** download files until the display reads "READY" as this can lead to an incorrect or corrupted file download. Corrupted file downloads can lead to an incorrect firing of the laser which can destroy the material you are engraving.



The two up and down arrow buttons to the right side the LCD give complete access to the menu control system. Use these arrow buttons to move the cursor up or down through the items in the display.



Both of these buttons each serves two purposes. Depending on which menu you are in at the time, the "SELECT" button either enters you into that menu item the cursor is currently on, or it toggles that menu item to display different choices. Some items in the display lead to other menus and some are settings that can be adjusted. The "ESCAPE" button, depending on which menu you are in at the time, either exits you back to the previous menu or it nullifies or cancels any changes that you have made to that menu item. Continuously pressing the "ESCAPE" button will eventually bring you back to the "MAIN" menu.

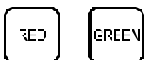

The indicator lights will act differently depending on the current state of the laser system. The chart below describes the conditions of the indicator lights during different modes of operation.



### Green Indicator Light

CONDITION	REASON
ON	The laser system is powered up, the top door is closed and the system is ready to receive a file
	The laser system has finished processing a file and has returned to the home position
	The laser system has been paused while running a file
OFF	The top or front door is open
	The laser system is firing the beam in the Alignment Mode
FLASHING	The file is running

### Red Indicator Light

CONDITION	REASON
ON	The laser system is initializing
	The laser system is firing the beam in the Alignment Mode
OFF	The laser system has finished initializing and is ready to receive a file
	The top or front door is closed
FLASHING	The top or front door is open

### The Process Controls

These control the actual running of the laser system.



Runs the current file displayed in the "File Display" menu.

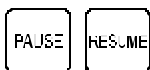

If a file is running, the "PAUSE" button halts the engraving or cutting process. When paused, the motion system arm will move to its home position in the upper right corner of the engraving area. When ready to continue operation, press the "RESUME" button and the system will begin cutting or engraving again exactly where it left off. If you wish to run the file from the beginning after pressing the "PAUSE" button, press the "START" button. When "**Curve Enhancement**" mode is selected in the driver, the "Resume" button acts like the "Start" button and will start your file from the beginning.

**NOTE:** During slow raster or vector motions, the motion system might not pause immediately after the "PAUSE" button is pressed. It can take a few seconds or several seconds to stop the system because it needs to complete the motion commands that it is currently running. Opening the top door also works similar to the "PAUSE" button but not exactly. The first thing the laser system will do is turn off the laser beam immediately after the door is opened. The next thing it will do is pause the motion system. Since opening the door and the pausing of the motion system are not precisely synchronized if you do this, resuming the file might cause an area of missed engraving. Opening the door to turn off the laser and to pause the motion system should only be used for safety or emergency reasons.



The “NEXT FILE” button displays the next file in the systems memory and makes it the current file and will stop at the last file in memory. The “PREV FILE” button displays the previous file in the systems memory and makes it the current file and will stop at the first file in memory. These buttons are inoperative if a file is currently running.

### The Motion Control System

The motion control section of the control panel (the four directional arrow buttons) enables the user to manually control motion system movement.

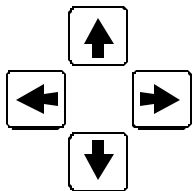

Pressing and holding down an arrow button will cause the focus lens assembly to move in the respective direction. The motion system starts off slowly, but if you continue to hold down the button, you will see it accelerate to a faster speed. Pushing the button once and letting it go quickly will move the motion system in .001 inch increments. Pressing two adjacent buttons will move the assembly in a diagonal direction. This part of the control panel is primarily used to position the focus lens assembly directly over the engraving material and to use the focus tool to set the proper focus height. Other uses for these buttons will be discussed later in this manual.



You must be in the “FILE DISPLAY” menu or the “MAIN” menu for this button to be operable. Pressing it enables the “ORIGIN POSITION” menu to appear. It also turns on the optional red laser diode that shows where the focus lens assembly is positioned in the field by shining a bright red “dot” on the engraving area. Further details on how to use this button will be covered later in this section.



This button positions the focus carriage slightly away from the upper left hand corner at the default (1,1) position in the engraving area. This is where the majority of focusing will be done. Once the focus carriage is positioned, using the motion control arrow buttons can still move the motion system. Pressing the button again will move the focus carriage back to the home position in the upper right corner of the engraving area. You can set the default position to anywhere in the field that you desire. Relocating the focus position is covered later on in this section.

# The Menu System

The LCD displays the menus of the laser system. Since this laser system has many features, we have included a "Menu System Flow Chart" on the next three pages. It diagrams and displays the menu items in the entire system and the button selections needed to access them. A description of each menu item follows the flow chart.

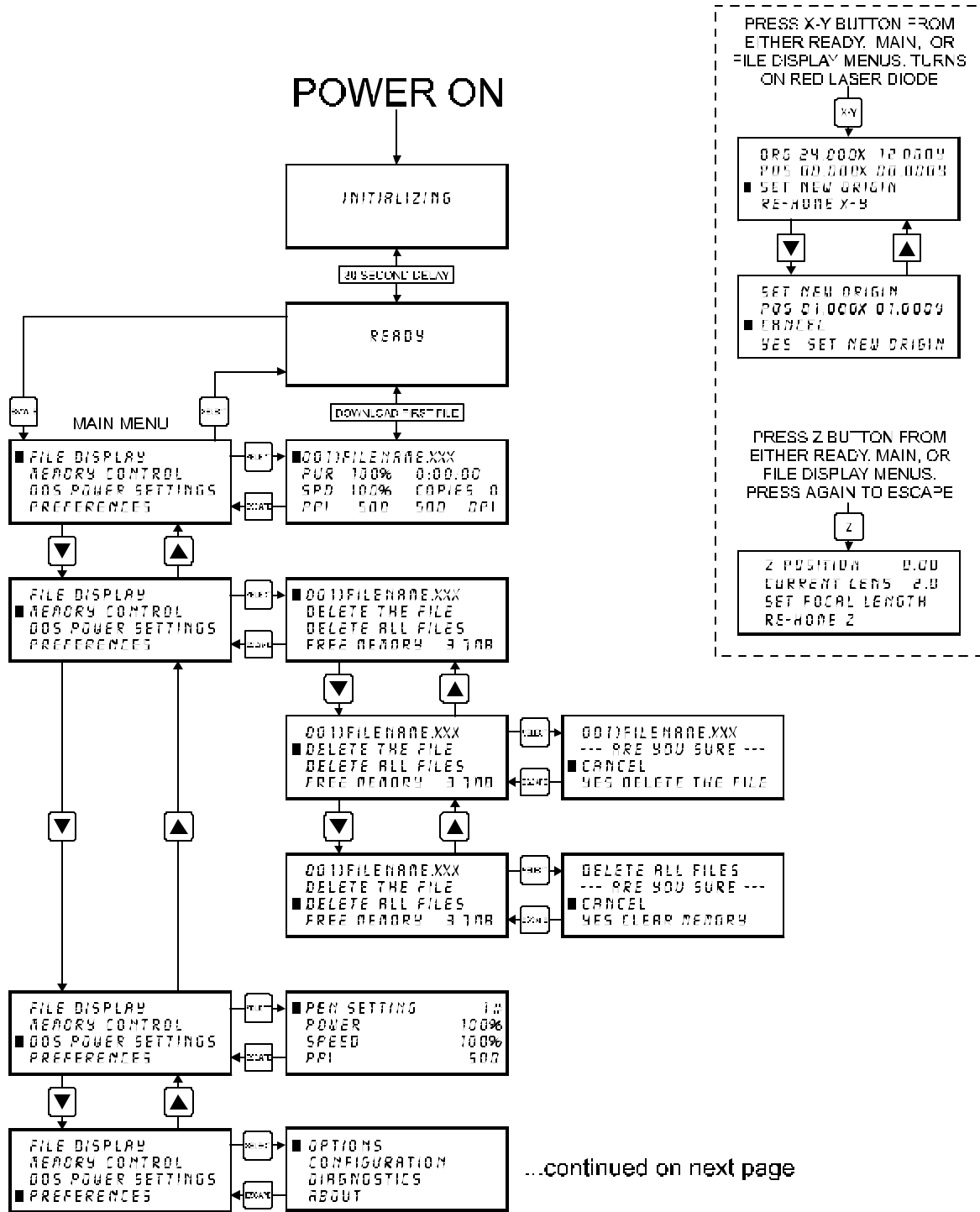

...continued on next page

...continued from previous page

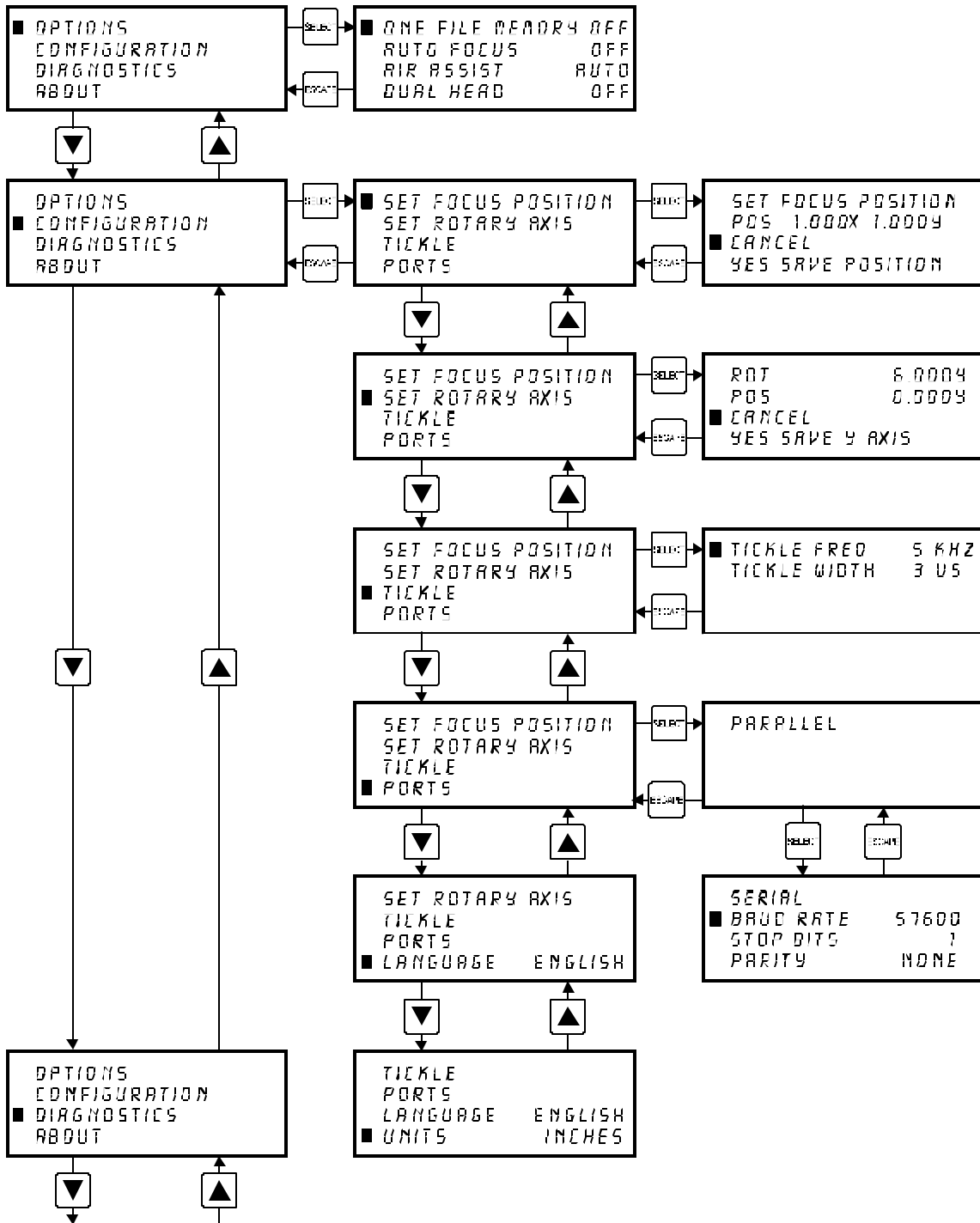

...continued on next page

...continued from previous page

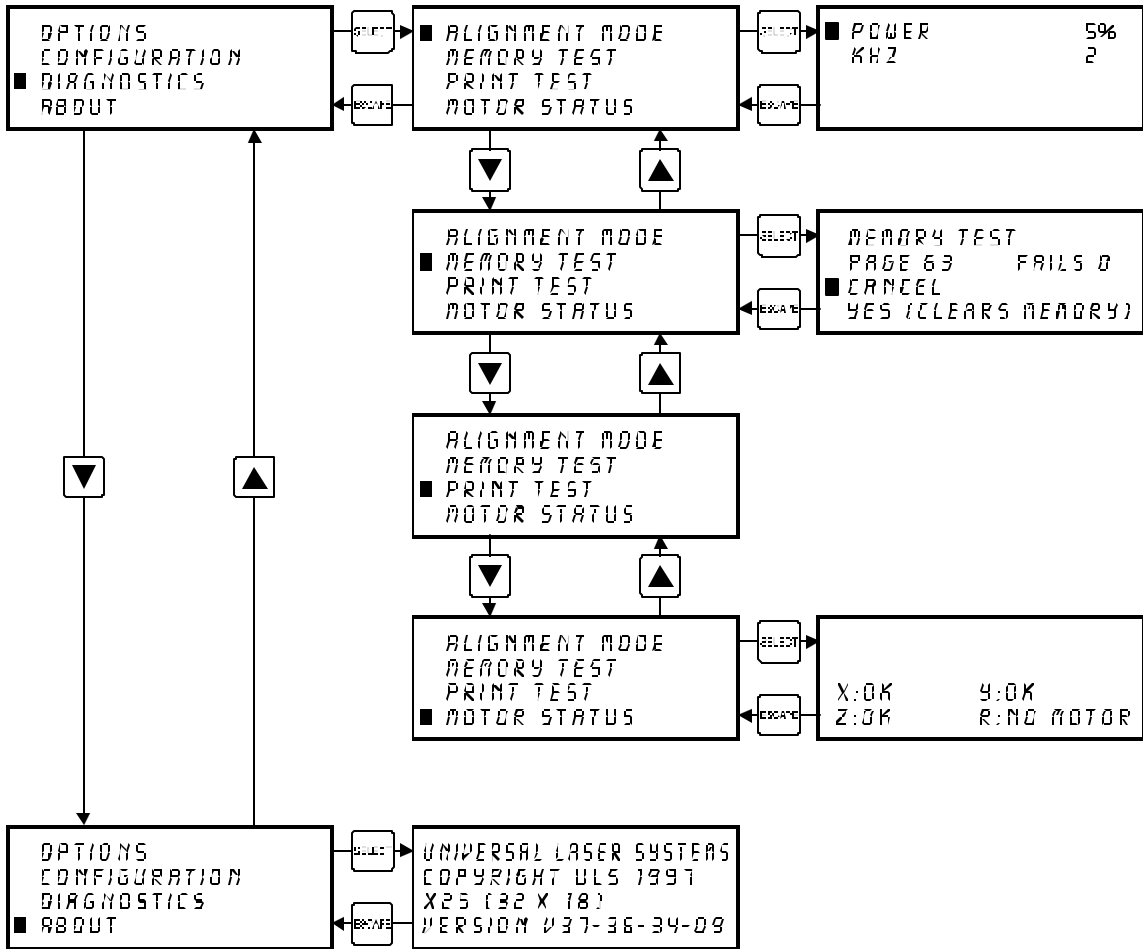

## Menu Descriptions

The remainder of this section will describe each one of the menus and their significance.

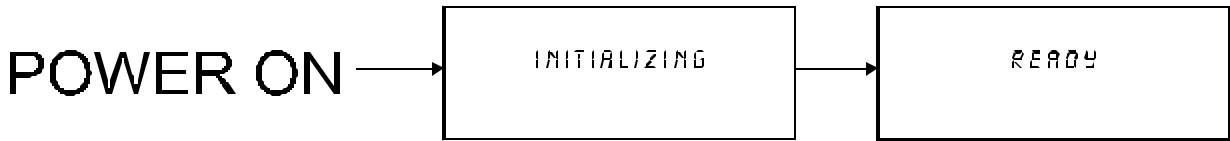

### READY Menu

When the system is first powered on "INITIALIZING" will appear for approximately 30 seconds until the laser system finishes performing its routine. When the system has finished initializing, "READY" will appear in the display, indicating that the laser system is ready to accept files.

```
■0011FILENAME.XXX
PWR 100% 0:00:00
SPD 100% COPIES 0
PPI 500 500 DPI
```

### FILE DISPLAY Menu

Appears automatically after the first file is downloaded completely into the laser systems memory. This is the menu that you will remain in most of the time when operating the laser system. It has been designed to show all pertinent operating information at a glance so that constantly jumping from menu to menu is not needed.

The first line indicates the filename. If more than one job has been downloaded, you can move to the next file in memory by pressing the "NEXT FILE" button. You can page through the list of files available in memory by placing the cursor on the first line of this display and pressing the "SELECT" button which move the cursor to the right side of the display. The up and down arrow buttons can then be used to move through the list of files in memory. When the desired file is found, simply press the "SELECT" button to make that file the current file. This will move the cursor back to the left side of the display. To run the currently selected file, simply press the "START" button. Changing the current file is not possible while the laser system is running. For experimental purposes, Power, Speed, and PPI settings can be altered while the file is running allowing you to adjust these settings until the desired depth or effect is achieved. To do this, press the up or down arrow button until the cursor is on the desired item. Press the "SELECT" button, which moves the cursor to the right, and then use the arrow buttons to increase or decrease the values. Pressing the "SELECT" button again will accept the change but pressing the "ESCAPE" button nullify the change and restore it to the original setting. It is possible to adjust the settings while engraving on some scrap material until the desired "POWER", "SPEED", and "PPI" settings are obtained. Note these settings, change them in the driver and re-send the file to the laser system for the final run.

**NOTE:** Since the file has the settings stored in the beginning of the data, you must first start the file before you can change the settings. You can then either pause the file, change the settings, and then resume the file or you can change the settings on the fly while it is running. Remember, these are only temporary changes so if you pressed the "START" button to start the file over again, it will take on the original settings that you sent down from the driver.

The display contains a timer to time files as they are run (this is useful for job costing). The timer will pause when the "PAUSE" button is pressed and starts up again when cutting or engraving has been "RESUME"d. If the same file is run again, the timer will count backwards displaying how much time is remaining. The "COPIES" feature indicates the number of completed runs of the file that is displayed. The DPI section displays the DPI setting from the driver. The "TIMER", "COPIES", and "DPI" readouts are for display purposes only and cannot be altered.

Since the laser system is equipped with a unique way of storing multiple jobs in memory, special provisions are made to distinguish one job from the next. When using the printer driver, an end-of-file (EOF) marker is automatically sent to the laser system after each file is downloaded. An end-of-file marker is needed by the memory buffer in order for it to recognize the end of one file, the beginning of the next file, and to calculate the remaining free memory space. Without an EOF, the memory buffer will not operate properly.

There are two ways that a downloaded file will have a missing EOF. The first is if printing through the printer driver and printing is canceled, interrupted, or file size exceeds the remaining free memory space. If this occurs, chances are that the EOF never made it to the memory buffer and the memory buffer will show that it is empty or that the file does not exist. Part of the file might still remain in memory and might become mixed up with other files. This is why having the ability to insert an EOF marker from the control panel of the laser system is very important. In order to delete that partial file, the memory buffer must either be cleared entirely or an EOF must be manually inserted into the memory buffer. Inserting an EOF is the better choice here because the partial file can be deleted without disturbing the other files in memory. Secondly, when using DOS based programs, a printer driver other than the Windows printer driver must be used. DOS printer drivers do not know to send the required EOF to the laser system after file downloading. Again, the memory buffer will not recognize any file that exists if it does not have an EOF. In this case, an EOF must be manually entered into the memory buffer after each and every file download from a DOS based program. Since DOS printer drivers also do not send the name of the file within the file data, every file will be called "NONAME" once an EOF marker has been inserted. To distinguish one "NONAME" file from the next, the display will number the files in the order from which they were downloaded.

To insert an EOF marker in either case, position the cursor on the first line of the display where the filename is. Press and hold down the "NEXT FILE" button and then press the "SELECT" button at the same time. The word "NONAME" will appear if there is a partial file in memory or any DOS based file that does not have an EOF marker. What has happened is that the laser system searched for any file information that had entered into the memory buffer since the last completed file was downloaded. If it finds information, it scans to the end of the last bit of that information and inserts an EOF. The file then shows up on the display as "NONAME" and will allow either its solitary deletion without having to delete the other files in memory or it will allow the file to be run just as if it was downloaded from the Windows printer driver.

```
■ FILE DISPLAY
MEMORY CONTROL
DOS POWER SETTINGS
PREFERENCES
```

**MAIN Menu**

Allows access to all other menus.

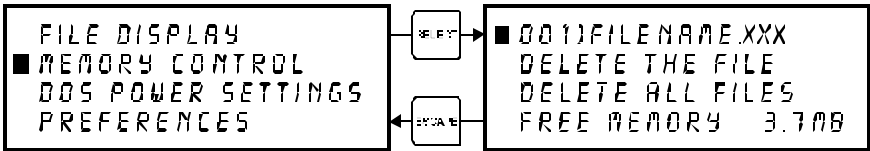

**MEMORY CONTROL Menu**

The laser system is equipped with an intelligent memory buffer that has built-in file compression. The driver actually compresses the file while it downloads to the laser system and the laser system decompresses the file while it runs. The amount of compression can be as little as 4 to 1 or as great as 48 to 1. This means that with 4 MB of RAM in the laser system, the buffer could hold the equivalent of 192MB worth of files provided they can be compressed

## 5-12 System Operation

---

48 to 1. This gives the laser system the ability to store either larger or more files in memory. It also provides for quicker downloading because the files are much smaller than normal. The memory buffer can hold up to 999 files providing that the memory space is not exceeded. The memory also has built in file handling intelligence enabling each individual file in memory to be run in any order. The files are stored sequentially based on the order in which they were sent from the computer and each one is assigned a number to keep them in order. A running total of the free memory space available is provided at the bottom of the display. The file name displayed is always the currently active file and there are two methods for looking through the list of files to choose another one. The first method is to press the "NEXT FILE" button on the control panel. Each time the "NEXT FILE" button is pressed, the next file in memory becomes the current file. The second method is to move the screen cursor to the file name line and press the "SELECT" button to move the cursor to the right side of the display. Then, use the up and down arrow buttons to move backward or forward through the list until the file desired is displayed. Now, press the "SELECT" button again to bring the cursor back over to the left side of the display.

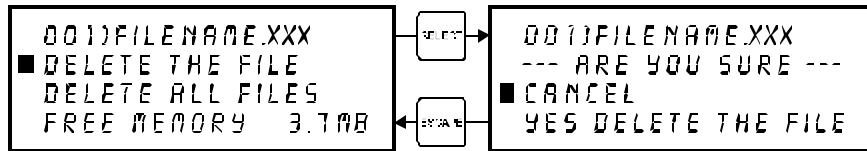

Eventually the memory will fill up with files that will need to be deleted to free up space for more files. It is possible to select each individual file and delete them one at a time. To accomplish this, make the desired file for deletion the current file in the same manner as previously described. Use the up or down arrow buttons to position the cursor on the "DELETE THE FILE" menu item and then press the "SELECT" button.

The display will then ask if you are sure and will expect a "CANCEL" or a "YES" response. Use the up and down arrow keys to position the cursor on the appropriate choice and press the "SELECT" button.

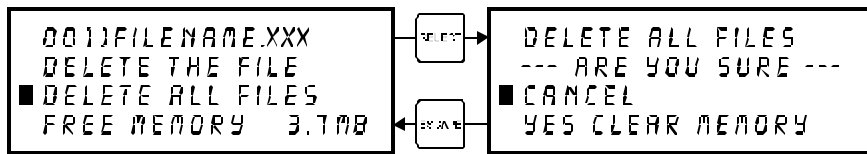

To completely clear out the entire memory buffer all at once, use the up and down arrow keys to position the cursor on the "DELETE ALL FILES" option and press the "SELECT" button. The laser system will again ask if you are sure so respond accordingly.



Deleted files cannot be undone. They must be re-downloaded if you accidentally delete them.



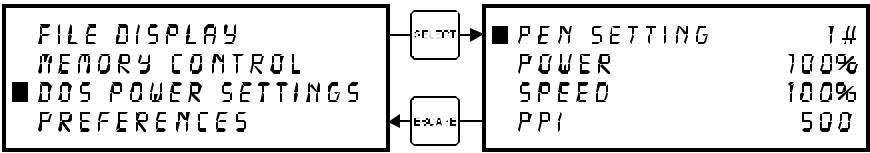

**DOS POWER SETTINGS Menu**

The laser system allows eight different power settings to be saved, in non-volatile (permanent) memory, and used when processing a DOS based file. Since DOS based printer/plotter drivers do not have the ability to set the “POWER”, “SPEED”, and “PPI” settings, the settings must be set manually on the laser system. Think of it as being able to assign laser “POWER”, “SPEED”, and “PPI” to the pen numbers of a flatbed plotter.

To access these settings, move the cursor to the “DOS POWER SETTINGS” menu and press the “SELECT” button. Press the “SELECT” button again to bring the cursor to the right side of the display where it sits on top of the pen numbers. Now use the up and down arrow buttons to scroll through settings 1 through 8. When the desired pen number is found, press the “SELECT” button again to bring the cursor over to the left side of the display. Bring the cursor down to the item you want to change, again press the “SELECT” button to bring the cursor to the right and use the arrow keys to adjust your settings. Remember, to accept the setting that you have made, press the “SELECT” button to bring the cursor back over to the left side of the display. Pressing the “ESCAPE” button nullifies your change. Once you have set the correct settings for all of the pen numbers that you will be using in your DOS software, press the “ESCAPE” button to bring you back to the “MAIN” menu. Your settings will be permanently stored just as long as you exit back to the “MAIN” menu before turning off the laser system. For more information on how to use DOS based programs with the laser system, please refer to the Appendices section in the back of this manual.

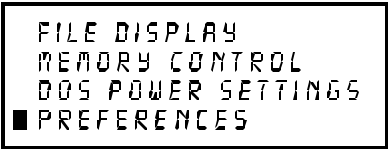

**PREFERENCES Menu**

The primary function of this menu is to allow access to other menus that can reconfigure the laser system. It also allows access to diagnostic and maintenance features. Selecting this option will lead to other menus of which some are adjustable and others that are display only.



Always escape back to the “MAIN” menu before turning off the laser system. This will permanently store your changes in non-volatile memory. If you turn off the laser system without escaping completely back to the “MAIN” menu then your changes would not have been stored and the system will revert back to its previous settings.

## 5-14 System Operation

---

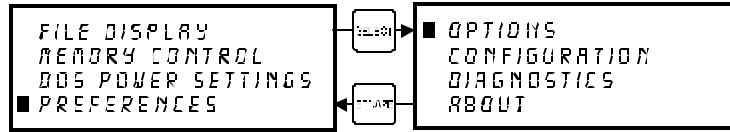

### OPTIONS Menu

Selecting this menu will allow the access to turn on certain options that the laser system might have.

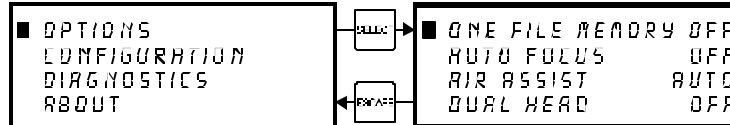

### ONE FILE MEMORY Menu

Pressing "SELECT" key while cursor is on this line will toggle the setting on and off. When off, it enables the multiple file memory buffer system (default). When on, it disables the multiple file memory buffer and stores only one file at a time. How it works when it is turned on:

When you download a file to the laser system that file will appear in the "FILE DISPLAY" menu. Press the "START" key and run the file just as you would as if you were in the multiple file memory mode. You can run this file as many times as you want because it remains in memory.

Now, as you download the second file, observe the display and you will see "MEMORY EMPTY" flash momentarily and then the new file appears. Basically what has happened it that the laser system clears out the entire memory as the new file comes in to replace the first file. You can now run that second file as many times as you want. If you download another file, it dumps the entire memory again and the new file becomes the only file in memory, and so on.

While in this mode, the parallel port is turned off so no new files can be received until the file is finished running. This is to prevent the incoming file from erasing the file that is running.

### Helpful Hint

You will notice that while in this mode of operation, all files downloaded will be labeled as the #1 file in memory. This might be confusing especially if you continuously download files with the same name. If you do this, you might question yourself whether or not you downloaded the next file because if you look on the display, it shows the same file number and the same name as the previous file that you ran. But if you look further, the timer will show 0:00:00 and the "COPIES" will be 0 if the file has never run. If the file did run, the "COPIES" will be greater than 0 and the time will show the amount of time that the file took to run.



### AUTOFOCUS Menu

Pressing the "SELECT" key while the cursor is on this line will toggle this option ON and OFF. Later in this section, we will explain how to use this option in more detail.

```
ONE FILE MEMORY OFF
AUTOFOCUS OFF
■ AIR ASSIST AUTO
DUAL HEAD OFF
```

**AIR ASSIST Menu**

This class of laser system does have Air Assist as an option, but it is not computer controlled. Since we use the same menu system on other models, this menu selection for your model does absolutely nothing. If you did purchase the Air Assist option for this model, please refer to the instructions that came with that option.

```
ONE FILE MEMORY OFF
AUTOFOCUS OFF
AIR ASSIST AUTO
■ DUAL HEAD OFF
```

**DUAL HEAD Menu**

This option is not available for this model of laser system.

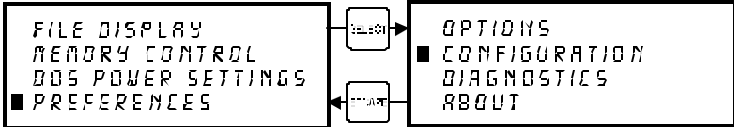

**CONFIGURATION Menu**

Selecting this menu will allow the reconfiguration of certain features of the engraving system and will lead to other menu items.

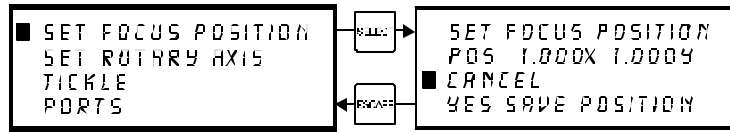

### SET FOCUS POSITION Menu

This option allows you to set the focus position to anywhere in the field that you desire. Normally, the factory default setting for the “Z” button is (1,1). If you would like to change the factory default setting, go to this menu and press the “SELECT” button. If you have the optional red laser diode pointing device, the light will appear on the engraving table to assist you in determining the position desired.

Using the motion control arrow buttons to position the focus carriage assembly. While you are doing this can observe the coordinate display change as you move the focus carriage. These coordinates are the current position of the focus assembly in the engraving field. Once the desired position has been located, bring the cursor down to the “YES SAVE POSITION” line and press the “SELECT” button. Press the “ESCAPE” button twice to exit back to the “MAIN” menu. Your settings will automatically be retained permanently in memory.

To restore the focus position back to the original factory setting, go back into this menu and press the up and down arrow keys simultaneously.



You will see the motion system move to the 1 inch horizontal and the 1 inch vertical position (factory default). Now select “YES, SAVE POSITION”. Press the “ESCAPE” button twice to exit back to the “MAIN” menu. Your settings will automatically be retained permanently in memory.

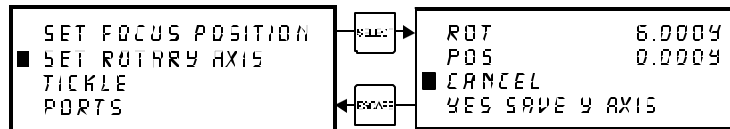

### SET ROTARY AXIS Menu

The Rotary Fixture Axis is a setting that is pre-set at the factory. The laser system will sense when the Rotary Fixture is plugged in and will position the X-Axis arm directly over the centerline of rotation automatically when it begins to engrave. This setting can be altered if you position the Rotary Fixture in a location **OTHER** than the factory set position. Please refer to the section on the optional Rotary Fixture for a full description on how to set up and use this device before altering any factory setting.

To change the factory default setting, turn the laser system OFF, place the Rotary Fixture on the engraving table in the desired position, and **DO NOT** plug the Rotary Fixture into the electrical socket. Now turn the laser system on and with the motion system arrow buttons, position the X-Axis arm’s focus lens carriage directly over the Rotary Fixtures centerline of rotation as the following diagram illustrates:

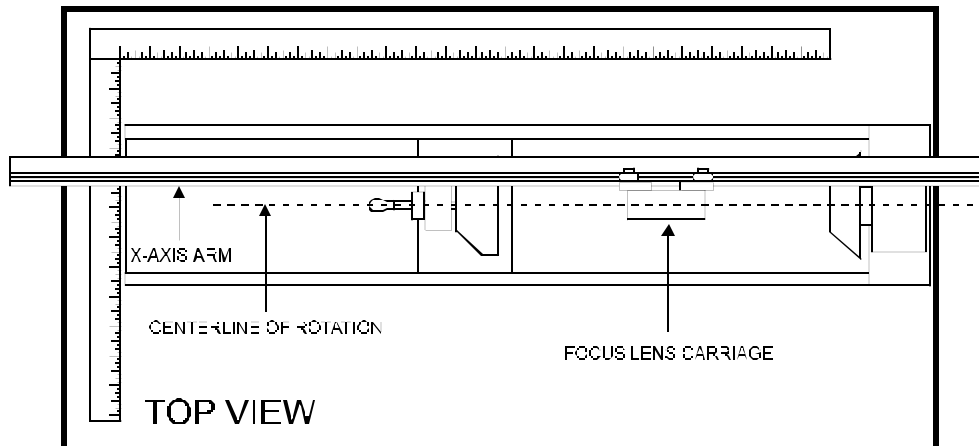

The left and right position (X-position) of the focus carriage is irrelevant in this setting and is not shown in the display. Now select the "YES SAVE Y AXIS" choice. If you change your mind and do not wish to alter the "ROTARY AXIS" position, select "CANCEL" instead and the original settings will be restored. Remember, always escape back to the "MAIN" menu before turning the system off so that your settings will be permanently stored in memory.



If you would like to get the Rotary axis back to the original factory default setting, go back into the "SET ROTARY AXIS" menu. While in this menu, press the up arrow and down arrow keys simultaneously. The arm move will move back to its original factory default setting. Select "YES SAVE Y-AXIS", and then press the "ESCAPE" key twice to exit back to the "MAIN" menu to store this setting permanently.

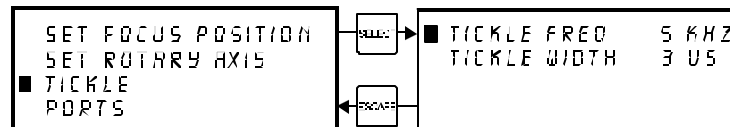

### TICKLE Menu

TICKLE is the term used for small pulses, which are fed to the laser to keep the plasma inside energized. This allows the laser to respond quickly and strongly for high speed cutting and engraving. The setting shown above is only an example. Your laser's setting may be different.

TICKLE keeps the laser "warmed up" at times when the laser system is powered on but not firing and the top door is closed. We suggest keeping the door closed at all times when the laser system is powered on as this keeps the laser warmed up. If the door is open, the power to the laser tube itself is turned off and the tube will cool down. The laser runs best after being warmed up for 15 to 20 minutes.

TICKLE is pre-set at the factory and usually does not require adjustment. However, it is possible that it may need adjustment after the laser system ages several years. DO NOT attempt to adjust the TICKLE setting. Please contact our Service Department for the correct diagnosis and corrective procedure.



### PORTS Menu

Two ports are provided on the back of the system for interface with a computer, a serial and a parallel port. Only one port can be used at a time. To activate a port, use the up and down arrow keys to position the cursor on the menu item “PORTS” and press the “SELECT” button. The menu that appears indicates the currently active port on the laser system. To toggle between ports press the “SELECT” button.

In order to use the “SERIAL” port, the communication settings **MUST** match those of the computer. Refer to the computer’s hardware and software manuals for details on setting up the computer’s serial port. If using the “SERIAL” port, select the fastest possible “BAUD” rate for communication since this effects how quickly the computer can send files to the laser system. For “BAUD” rates of “9600” and above, set the number of “STOP BITS” on the computer to a higher value than the number of “STOP BITS” selected on the laser system. For example if the number of “STOP BITS” on the laser system is set to “1”, then set the computer’s stop bits to “1.5” or “2”.

“PARITY” of the laser system and the computer **MUST** match exactly and the choices are “ODD”, “EVEN”, or “NONE”. Pressing the “SELECT” button while the cursor is on “PARITY” will toggle through these choices.

### Helpful Hint

Since the serial port works much harder than the parallel port does, it uses much more of the laser systems computer processors power to take in the files. Since this is the case, it is **NOT** recommended that you download a file while the laser system is running a different file. This can cause data corruption to occur to the file coming in to the computer. Either pause the laser system or wait until it finishes engraving the file before downloading the next one. This situation is for the serial port only. Disregard this warning message if you are using the parallel port for communications. The fastest method of file transmission to the laser system is the parallel port. Its use is highly recommended.

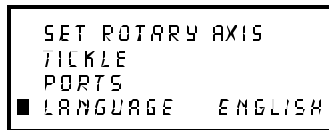

### LANGUAGE Menu

Use the “SELECT” button to toggle through many different language choices. When the desired language is displayed, press the “ESCAPE” button twice to exit back to the “MAIN” menu. Your settings will automatically be stored permanently in memory. When the cursor is on this menu item, continuously pressing the “SELECT” button will toggle the languages in a loop fashion and will always bring you back to the original language.

```
TICKLE
PURYS
LANGUAGE ENGLISH
■ UNITS INCHES
```

**UNITS Menu**

Use the “SELECT” button to toggle between “INCHES” and “METRIC” units. Once the desired unit is displayed, press the “ESCAPE” key twice to exit back to the “MAIN” menu. Your settings will automatically be retained permanently in memory. When the cursor is on this menu item, continuously pressing the “SELECT” button will toggle the units in a loop fashion and will always bring you back to the original units.

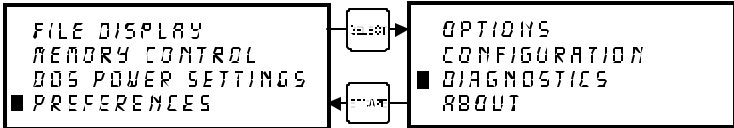

**DIAGNOSTICS Menu**

This menu leads to other menus that enable you to help diagnose problems, if they occur, with the laser system. It also will help our technicians solve problems that you may be experiencing.

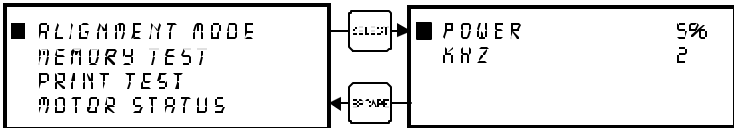

**ALIGNMENT MODE Menu**

This menu allows access to firing the laser beam manually to determine if the laser systems optical alignment is correct. The factory setting is a very low power setting that is just strong enough to check the laser beam alignment. Please refer to the maintenance section on how to safely check the laser systems beam alignment.

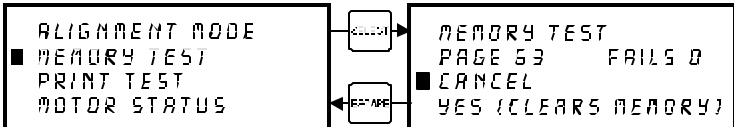

**MEMORY TEST Menu**

It may be necessary to use the diagnostic tests if instructed to do so by a member of our technical support staff. The “MEMORY TEST” is a memory buffer test to test the RAM in the laser system. This is very similar to the RAM test that your computer performs when it first gets powered on. In the process of testing memory, all files in memory will be erased. Once the “MEMORY TEST” is started it will continue to run until it is canceled. To start the test select “YES (CLEARS MEMORY)”. To end the test, select “CANCEL”. This test will continuously pass through the memory. If you are going to run this test, start it and let it run for about 10 minutes. If it finds memory that is bad, it will show up as a number other than a “0” in the fails column and the SIMM module will need to be replaced. Please contact technical support if there is a problem with the memory.

```
ALIGNMENT MODE
MEMORY TEST
■ PRINT TEST
MOTOR STATUS
```

**PRINT TEST Menu**

There is a built in test file in the menu system. To access this file, use the up and down arrow buttons to position the cursor on the "PRINT TEST" menu item and press the "SELECT" button. The display will get replaced with the text "001) MEMORY EMPTY". After a few seconds a test file name will pop up in the display. Place a piece of scrap material in the upper left hand corner, we recommend anodized aluminum, focus on the material, turn on the exhaust system, and press the "START" button. A test pattern will now engrave into the material that can help diagnose if there are any laser or mechanical problems with the system.

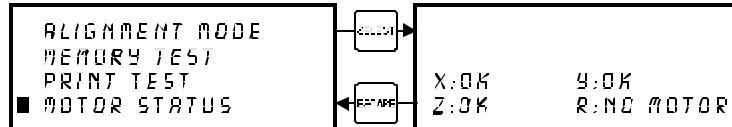

**MOTOR STATUS Display**

The last two lines of this display show the conditions of the stepper motors in the motion system. If there is a problem there will be an error message displayed next to the troubled motor. If the motor is completely disconnected, "NO MOTOR" will show in the display.

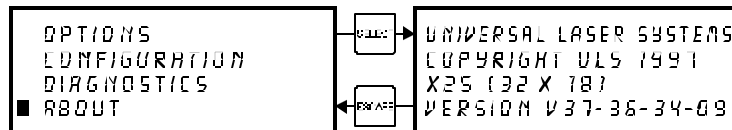

**ABOUT Menu**

Use the up and down arrow buttons to position the cursor on this menu item. Press the "SELECT" button and our copyright notice along with the current versions of firmware will be displayed. The firmware version numbers are a diagnostic aid to our service technicians. If you are having a problem with the laser system, a technician might ask you to read out the numbers in this display.

To access the following menus, the cursor must be located either in the "MAIN" or the "FILE DISPLAY" menus. They are not accessible if the cursor is in the "DOS POWER SETTINGS" or the "PREFERENCES" menus.



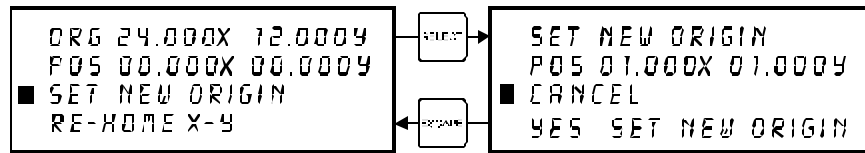

### ORIGIN POSITION Menu

The laser systems default origin position is in the upper left hand corner of the engraving area at the (0,0) position of the rulers. You can, however, position the origin to any other point in the engraving area. To do this you must first get into this menu. From either the "MAIN" menu or the "FILE DISPLAY" menu, press the "X,Y" button in the middle of the four motion system directional arrow buttons.

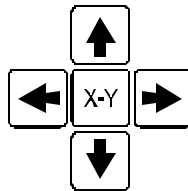

The red laser diode will appear on the engraving table. Using the directional arrow buttons, position the red dot at the location you would like to store as the new origin position. If you tap the motion control buttons, you will observe the motion system move at .001 inch increments. The longer that you hold down the button, the faster it moves. You can use either the digital display or the red dot as a reference for the new origin. When you have moved the red dot to the correct position, bring the cursor down to the "SET NEW ORIGIN" menu item and press the "SELECT" button. If you are sure with this position, move the cursor down to "YES, SET NEW ORIGIN" and press "SELECT" again. Escape out of the menu and your settings will be saved permanently in memory.



Setting a new origin other than the default (0,0) position will shrink your field size. If you already have files already loaded into memory that utilize the entire engraving area, and you set a new origin, part of that graphic might fall out of the effective printing area. If you run this file, unexpected results can occur that might destroy your material in the engraving area. We suggest that you use this feature cautiously and make sure that you do not set a new origin that would cause you graphic to print off the engraving area.

If you would like to reset the origin back to the original factory settings of (0,0) in the upper left corner, a quick way to get the motion system back to the upper left corner is to simply press the up arrow and down arrow keys simultaneously while in this menu.



You will see the carriage move to the upper left hand corner automatically. Again, select "SET NEW ORIGIN", then select "YES, SET NEW ORIGIN" and your settings will automatically be stored in memory permanently.

## Focusing the Laser Beam

To properly focus the laser beam onto the surface of the material, you need to perform two tasks. First position the focus carriage directly above the material and then use the focusing tool or the digital display to adjust the Z axis table level until the material is at the proper distance away from the focus lens.

Place your material into the upper left corner of the engraving field against the rulers. From either the "MAIN" or FILE DISPLAY" menus, press the "Z" button located on the control panel.



You will observe the focus carriage move to a pre-set focusing position of (1,1). The display will now show the "CURRENT LENS" that you are using and the current vertical "Z POSITION" of the engraving table.

```
Z POSITION      0.00
CURRENT LENS   2.0
SET FOCAL LENGTH
RE-HOME Z
```

The cursor in the display will be flashing on top of the tenths digit. You can now move the table up or down by pressing either the up or down arrow button. If you push the button once and let go quickly, the table will move in .1 inch increments. If you hold down the button, it will move fluidly. To make finer moves, press the "SELECT" button to bring the cursor over to the hundredths digit. Pressing the up or down arrow button once and letting go quickly will move the table in .01 inch increments. Holding down the button will make it move fluidly. Practice moving the table up and down to get the feel of it before you attempt to focus on a material. We will explain the significance of the numbers in the display a little later on but for right now, press the "Z" button to bring the focus carriage back into the home position.

Essentially, there are three ways to focus on your material. One is to use the focus tool, another is to enter in the thickness of the material, and the other is to use AUTOFOCUS.

### The Focus Tool Method

Place your material onto the engraving table. Visually make sure that the height of the material will not interfere with the focus carriage when you move it over the material to set focus. Press the "Z" button and observe the focus carriage move to the (1",1") position in the engraving area. If this is not a good focus position for you, use the motion system directional arrow buttons to position the focus carriage directly over your material. Use the up or down arrow buttons to move the table so that the flat side of the tool can sit flat up against the side of the focus carriage. Slowly raise the table until you observe the tool either tilting or sliding away from the focus carriage. This will occur when the bottom edge of the focus carriage meets with the top of the beveled edge of the focus tool. The objective is to stop the table at the point where the tool just starts to move or tilt.

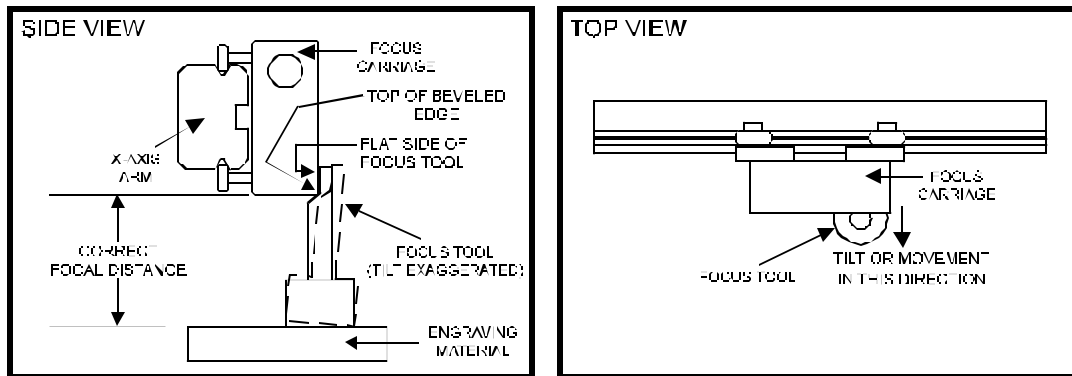

Remember, having the cursor, in the display, located on the tenths digit will move the table quickly and having it on the hundredths digit will move it more slowly. After focus has been established, remove the focus tool and press the “Z” button to move the focus carriage back into the home position.

If you find that you need to place your materials in a position other than the upper left hand corner, you can change the default focus position to anywhere in the field that you like. Please refer to that menu item selection earlier in this section.

### The Material Thickness (Z POSITION) Method

The second method is to enter in the thickness of the material into the “Z POSITION” display. This method does not involve the use of the focus tool. For example, using a caliper or some other thickness measuring device, measure the thickness of your material and enter that thickness into the “Z POSITION” display. For example, if your material is 1 inch thick, use the up or down arrow button to raise or lower the table until the digital display reads “1.00”. That is all you need to do. Now press the “Z” button again to bring the motion system back to the home position. The beam is now precisely focused on the surface of your material. Think of it as using an imaginary focus tool.

The laser system table has been set up at the factory to read “0.00” when the beam is focused to the surface of the table when the lens that is installed on the focus carriage matches the “CURRENT LENS” in the display.

The factory has only set the “0.00” point for the lenses that you purchased at the time the system was shipped. If you purchase additional lenses, you will need to set the “0.00” point, also called the “FOCAL HEIGHT”, for each lens.

### CURRENT LENS Menu

There are 4 lenses available, 1.5, 2.0, 2.5, and 4.0 inch lenses. All of them have different focal lengths so this is why we need to have a different “FOCAL HEIGHT” position for each lens. If you press the “SELECT” button while the cursor is on this menu item, you will see the right side of the display toggle into the different lens heights. You will also notice that the “Z POSITION” display change to reflect the difference in focal lengths. If you have purchased all of the other optional lenses with the laser system, all of the focal lengths have been set for you. If you just purchased the standard 2.0 lens, only that “FOCAL HEIGHT” was set at the factory. This is due to the fact that all lenses have slightly different focal lengths even if they are both 2.0 inch lenses so each one’s “FOCAL HEIGHT” must be calibrated on the machine.

### SET FOCAL HEIGHT Menu

Use this selection to set the “0.00” for each lens. Using the focus tool that matches the “CURRENT LENS” displayed, position the table so that the laser will be focused on the table’s surface. If the display does not read “0.00”, move the cursor down to the “SET FOCAL HEIGHT” menu item and press the “SELECT” button. The display will ask “ARE YOU SURE?”. Move the cursor down to “YES” and press the “SELECT” button. The “Z POSITION” display will now read “0.00” and will be **PERMANENTLY STORED IN MEMORY** until you do this procedure again. If you have purchased other lenses, you can set each of their focal heights by making that lens the “CURRENT LENS” and repeating this procedure.

### The AUTOFOCUS Method

In order to use this method, you must first turn it ON. We described how to turn it ON earlier in this section. After you turn it ON, please follow the step by step instructions below.

#### To Use AUTOFOCUS:

- The AUTOFOCUS sensor sends out an invisible beam across the table between the 1 inch and the 3 inch mark in the Y axis ruler for the M series and the 2 and 4 inch mark for the X series laser systems. You will notice that it is indented slightly.
- Place your object between these two points vertically and anywhere on the table horizontally. Refer to the diagram below.

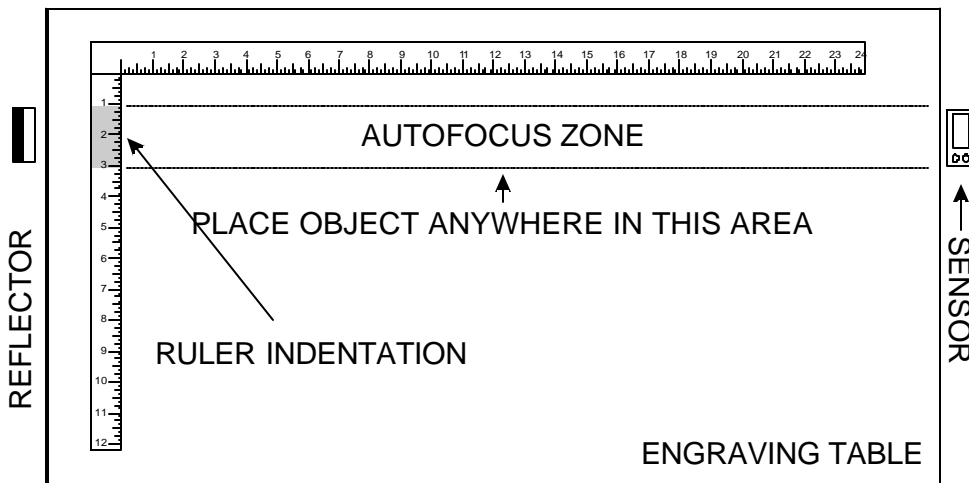

- Make sure that the laser system is in the main menu screen or the “File Display” menu. AUTOFOCUS will not work in the other menus.
- Press the “Z” button once on the control panel of the laser system. You will observe the Z-axis Table (Engraving Table) move down and then up again, adjusting the table to the proper focusing height. If the “Current Lens” choice in the menu system is not the same as the lens you have installed, correct it by placing the cursor on the second line of the display, and pressing the “Select” button to toggle you through your choices. Once the desired lens is displayed, escape out of the menu and AUTOFOCUS again. This will bring the table up to the correct height. The display will now show that the “Z Position” is “0.00” for that Focus Lens.

- If you desire to adjust the “Z Position” so that you are slightly out of focus, without exiting out of the menu, simply bring the cursor over to the “0.00” part of the display and adjust the table to the desired offset. The display will now show you how much you are out of focus. If you were to escape out of the display and perform the AUTOFOCUS procedure again, the “Z Position” will again show “0.00” to remind you that you are precisely in focus.
- If you have purchased additional lenses besides the 2.0 inch lens upon original delivery of the laser system, those other lens heights have been set at the factory. If you purchase additional lenses after you have received your machine and need to set the ‘Focal Height’ of that lens, or you need to adjust your AUTOFOCUS, please follow the next procedure.

### **To Adjust AUTOFOCUS:**

From time to time, you may need to re-adjust your AUTOFOCUS. The only time that you should need to re-adjust the AUTOFOCUS is when you have received a new or different length Focus Lens, have recently Flash upgraded the operating system of the laser, or had a dirty sensor or reflector and are adjusting it after you have cleaned those parts.

- Place a very flat object on the Engraving Table, within the AUTOFOCUS Zone, that is at least 1 inch thick.
- AUTOFOCUS on this object by pressing the “Z” button once.
- While you are still in the “Z Position” display, move the Focus Carriage using the motion control keys so that it is above your object that you placed on the table.
- Place your Focus Tool on top of your object and compare the Focus Tool reading with the actual height that the AUTOFOCUS set the Engraving Table to. If it is not the same, bring the cursor up to the first line of the “Z Position” display and press the “Select” button. Now focus on your object by using your Focus Tool and adjusting the “Z Position” until you are manually focused on top of your object.
- Press the “Escape” button, move the cursor to the “Set Focal Length” line and press “Select”. It will ask you if you are sure so move the cursor down to the “YES” line and press “Select”. The AUTOFOCUS will now have been re-adjusted to be exactly at the same height as your Focus Tool. The purpose of “Setting the Focus Length” is to calibrate AUTOFOCUS with your Focus Tool so that whether you use AUTOFOCUS or use the Focus Tool, you will always be putting the Engraving Table at the correct focusing height.
- If you have purchased additional lenses, repeat this procedure for each lens by changing the “CURRENT LENS” on the display and your focus tool, to the one you are calibrating.

### **AUTOFOCUS Maintenance:**

If the AUTOFOCUS reflector or sensor becomes dirty from engraving smoke, it may malfunction. A sign of AUTOFOCUS malfunction is upon activation, the table either moves all the way down to the bottom or all the way up to the top and will try to keep on moving until you power the machine off. If this did happen, you will need to clean your sensor and reflector and then perform the AUTOFOCUS adjustment procedure. An indication that the sensor and reflector are clean is that you will see a little green light appear on the side of the sensor. If you see both green and red lights, the sensor and/or reflector are dirty or blocked. **NOTE: Make sure that the table is down far enough so that the sensor “sees” the reflector before assuming that there is a problem.**

To clean, dampen a tissue with water and gently wipe across the sensor and reflector in one direction. Gently wipe again with a dry tissue.

---

**SECTION 6**

# Running the System Step by Step

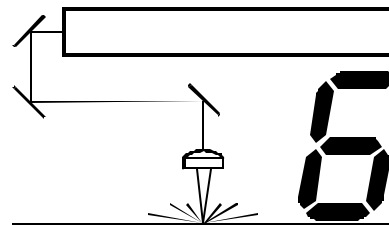

In this section we will cover how to completely use the laser system to create a product from start to finish. From powering on everything to removing the finished product from the system, we will cover the entire process step by step. As an example, let's engrave and cut out a key chain from a 2 by 4 inch, 1/8 inch thick piece of hardwood.



**Before continuing, please ensure that you have completely read and understood the entire manual up to this point. It is essential that you know how to safely operate the laser system before you actually engrave or cut any material.**

## Powering Up

We recommend that you turn on your computer first and let it boot up completely before powering up the laser system. This will prevent any garbage information that might have traveled out the printer port from entering the laser system during power up. This common practice should be utilized for all output devices whether it is a laser printer or a laser engraver. If you happen to power up the laser system first and then power up your computer afterwards, there is a possibility that some garbage information gets transmitted to the laser system. If you then send down a file to print, that garbage may confuse the laser system and cause it to engrave erroneously which could damage your material. This is why we recommend turning on your computer first before the laser system as a safe practice.

## Loading and Positioning the Material

The next step is to load and position the wood on top of the engraving table inside the laser system. Open the top door and position the piece of wood into the upper left hand corner of the table against the rulers as the diagram below indicates.

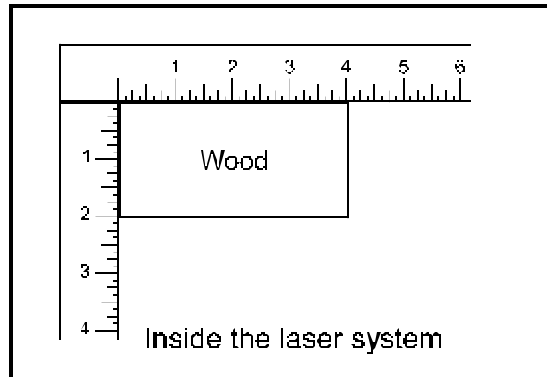

## Focusing Methods

Before attempting to adjust the focal height, visually check to make sure that the table is down low enough to prevent the focus carriage from hitting into the piece of wood.

With the top door still open, press the "Z" button on the control panel of the laser system. You will see the focus carriage move to the (1,1) position directly over the piece of wood. Using the focus tool, material thickness, or the Autofocus method, adjust the table until the proper focal height is achieved.

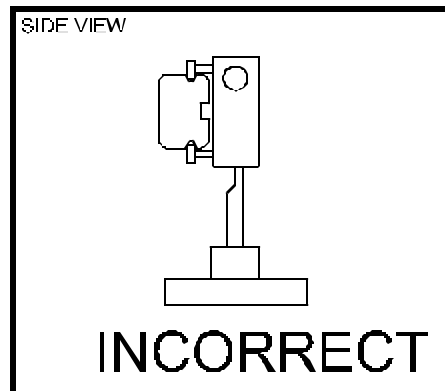
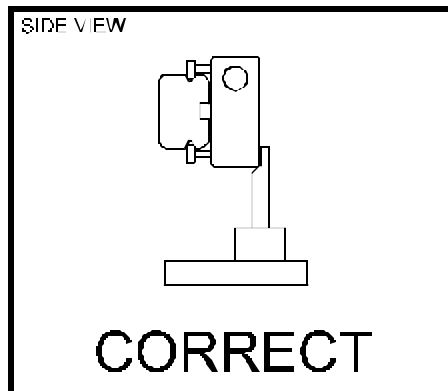

**WARNING:** Be careful not to position the tool underneath the focus lens as this can damage the lens if the table is driven up into it.

Sometimes it is desirable to be slightly out of focus when engraving or cutting. It widens the beam at the surface of the material to soften the image or create a wider cut line.



**WARNING:** DO NOT engrave or cut too far out of focus, as this can be a potential fire hazard. A maximum of .1 inches above or below precise focus should be the limit.

It does not matter whether you bring the table up to go out of focus, or down, the effect is the same. You should experiment on some scrap material at another time and note the difference. In this example, we will engrave in precise focus. Once you have established focus, store your focus tool and close the top door.

## Creating the Graphic

In your graphics program set your page size to the maximum size of the engraving area, 24 inches wide by 12 inches tall in the Landscape mode. Create some text with a **BLACK** colored fill and **NO** outline. For example, type in the word “Keychain”. Draw an outline box around the text, color the outline **RED**, give the outline a thickness of .00005 inches (or the smallest possible line width), remove the fill color (if any), and round the edges if desired. Now add a circle with the same **RED** outline .00005 inches (or the smallest possible line width) and **NO** fill, for the key ring. Place the graphic into the upper left corner of the page, on screen, relative to how the piece of wood is positioned in the engraving area as the following diagram illustrates:

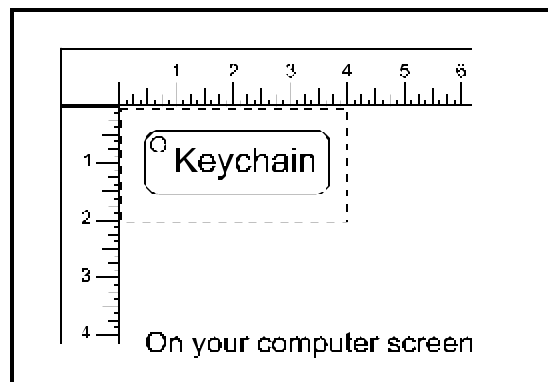

## Setting the Drivers Properties

The next step is to set the drivers properties. From within your graphics program, get to where you can see the driver parameter screen. Usually, there is a menu item called “Print Setup” or “Print Options” that allows access to the printer driver screen from your graphics software. For specific instructions on how to access the printer driver from your graphics software, please refer to your graphics software instruction manual or online help screens.

Once the printer driver is visible, click on the appropriate tabs and set the drivers parameters to the appropriate settings. For an example of power settings for a particular material, please refer to Section 8 of this manual.

## Downloading the File

You are now ready to print to the laser system. Make sure the laser system is powered on and the display reads “READY”.



Find the “PRINT” command within your graphics program and click on it. Depending on which graphics program you are using, the menu command “PRINT” may be in various locations within your program. Usually after clicking on “PRINT”, you will then need to click on “OK”.

A status screen may now appear showing a percentage of completion. Once this status screen disappears, it does not mean that the file is totally in the laser systems memory. If you have the Windows 95/98 print spooler turned on, it can take several seconds to even minutes, depending on your file size and the speed of your computer, before the entire file loads into the laser systems memory. Once the entire file is completely loaded, the display on the laser system will automatically update and will display the file’s name and the power settings that you assigned to the first color. Once this appears, file download is now complete.

## Starting the Engraving Process

Before pressing the “START” button on the control panel:

- Turn on your exhaust system.
- Make sure your material is positioned correctly within the engraving area.
- Make sure that you are properly focused.
- Make sure that the doors are closed and the RED light on the control panel is not flashing.
- Make sure the display shows the name of the file that you are going to run.

If all of the above has been verified, press the “START” button on the laser systems control panel to begin the engraving process.



Observe that the laser system is functioning as desired. If any abnormalities are present, including but not limited to, flaming, sparking, melting, or excessive smoking of the material you are engraving, **STOP THE ENGRAVING PROCESS IMMEDIATELY BY EITHER PRESSING THE “PAUSE” BUTTON OR OPENING THE TOP DOOR!** Re-check your settings in the printer driver as well as the laser system. If everything seems to be correct, the material is not suitable for laser engraving or cutting and you **MUST DISCONTINUE** processing this material or any material that shows impending signs of damage to the equipment.

We will also remind you again to please comply with the warning label below.



## Material Removing and Reloading

Once the laser system has completed processing your material, the laser beam will turn off, the motion system will move to its home position in the upper right hand corner, the system will beep twice, and the green light on the control panel will glow continuously.

Before opening the top door, wait a few seconds to let any remaining fumes that are leftover from the engraving or cutting process, evacuate through the exhaust system.

Open the top door and remove your material. Some materials will continue to out gas for several minutes to sometimes hours after the engraving or cutting process is completed. We recommend that you move these materials to a well-ventilated and unoccupied area.



**Some materials, when engraved or cut with a laser, can produce toxic and caustic fumes. We suggest that you obtain the Material Safety Data Sheet (MSDS) from the materials manufacturer. The MSDS discloses all of the hazards when handling or processing that material. The law requires all manufacturers to provide this information to anyone who requests it. DISCONTINUE processing any material that shows signs of chemical deterioration of the laser system. Systems damaged from this abuse will NOT be covered under warranty.**

While the top door is still open, load in your next piece of material. If it is the same as the previous one and you want to run the file again, simply close the top door and press the "START" button again to start the process from the beginning.

For further information on running the laser system in a different manner other than what has been described in this section, please refer to the previous section on "System Operation".

## SECTION 7

## Options &amp; Accessories

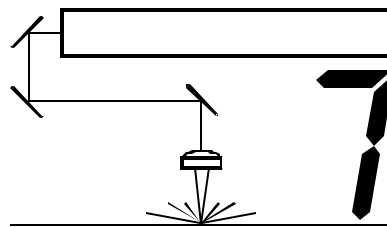

There are several options and accessories available for this laser system. The new 3D Effects option is now available as a standard feature. The Rotary Fixture, Cutting Table, Air Assist System, Air Assist Compressor, various Focus Lens Kits, and the Dual Head option are available at additional cost.

## 3D Effects

The 3D Effects option can be used to create rubber stamps or produce a three-dimensional engraving appearance on other materials. As an example of how this option works, we will describe how to make rubber stamps with the laser system.

## Rubber Stamps

There are two methods used to create a rubber stamp, the single stamp method and the full sheet method. In the following examples will show you the step by step method of creating both a single rubber stamp and a full sheet of stamps.

## Single Stamp Method

To create the artwork and engrave only one or a few stamps, set the page size in the graphics program to something smaller than the full field. Just as an example, we will use a page size that is 8.5 x 11 inches (215.9 x 292.1 mm) in the Landscape mode. In this way we can output to a paper printer, before engraving, for proofreading. Make sure that this page size is set up the same in the printer driver. Create a negative style stamp by drawing a black box slightly larger than the size of the stamp desired. Type in or add graphics within that area and color them with a fill of white. If you want the laser to cut out your stamp, draw a red outline box that is the smallest possible line thickness as your program allows. **Make sure that the red outline is inside the black box by at least .050 inches, otherwise there will be a little rubber strip of rubber sticking up around the border that will unintentionally appear when using the stamp.**



## 7-2 Options & Accessories

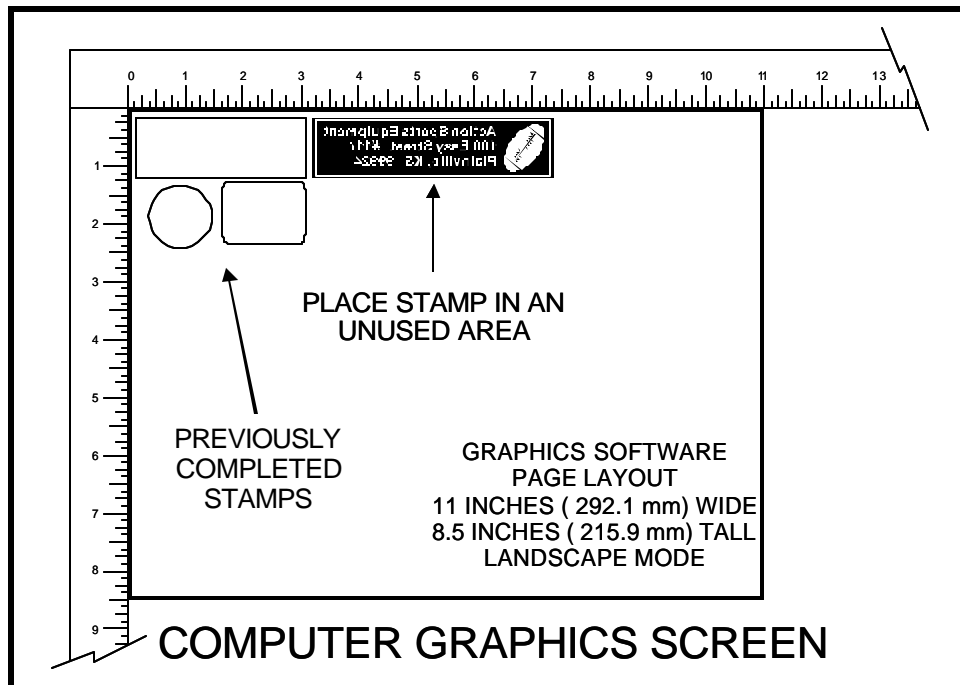

Place the stamp (on screen) where you want it to engrave in laser system. Avoid the spots where you have already engraved and cut out other stamps.

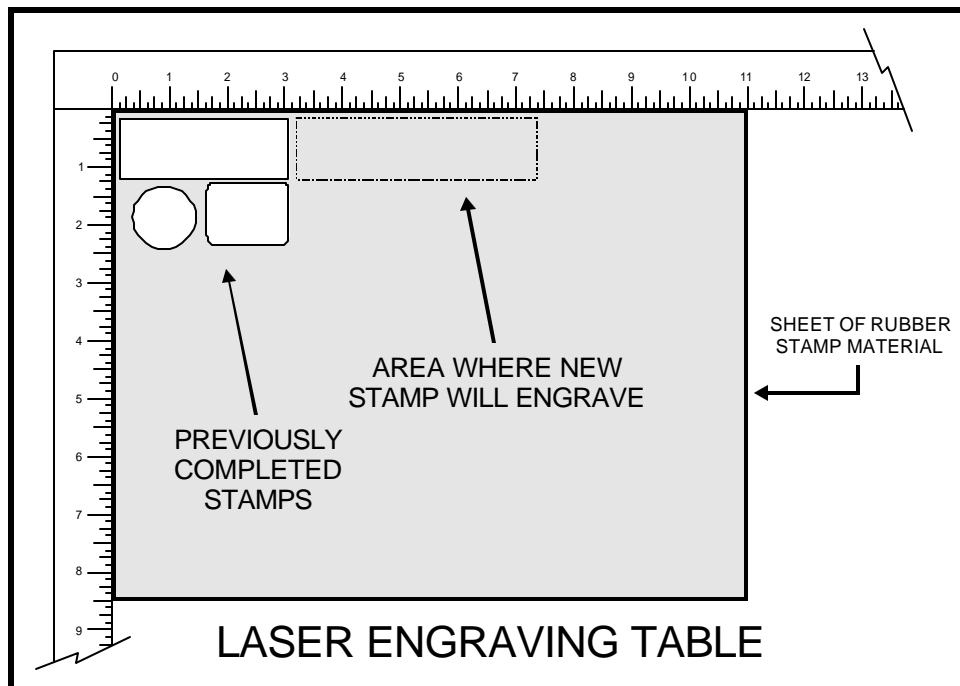

Place a sheet of rubber stamp material into the **UPPER LEFT CORNER** against the rulers, as the following diagram illustrates, and be sure to properly focus on the material. Now, set the printer driver settings as shown on the following page.

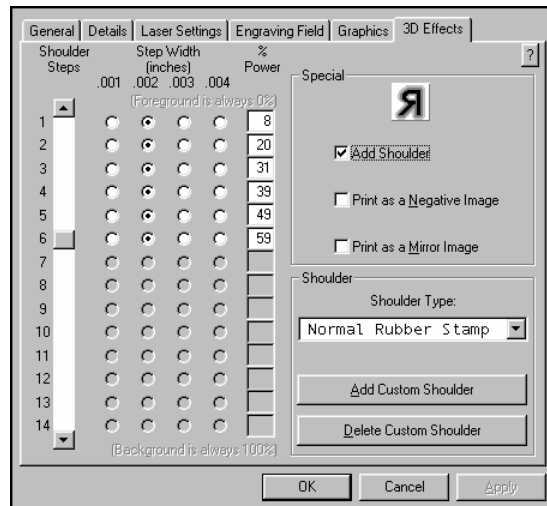
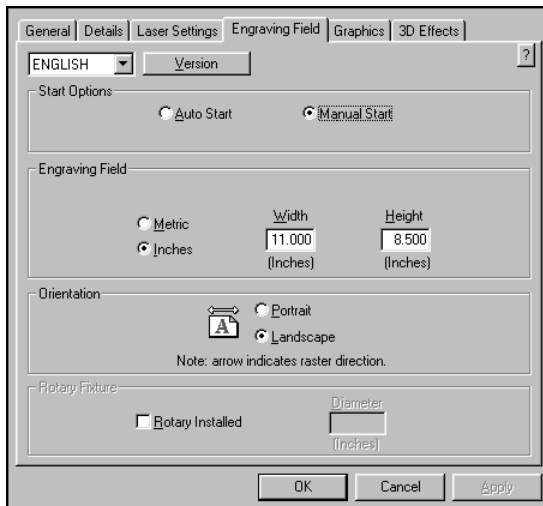
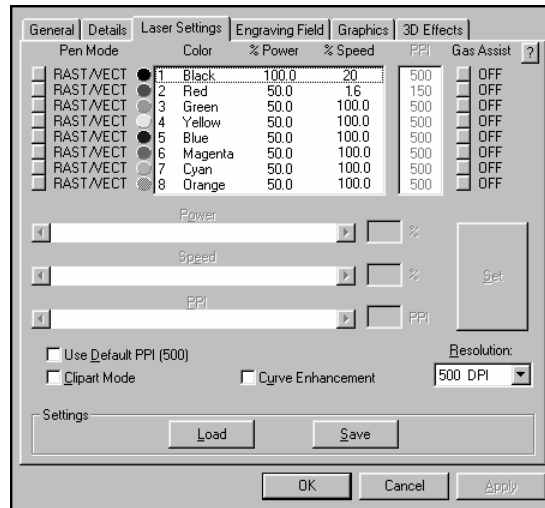

### Settings for the 30 Watt System

There is a considerable difference between rubber blends, thickness, and hardness between different manufacturers. Use these setting as a starting point for a 30 Watt system. For other sample power settings, refer to Section 8. You might need to experiment with different settings to obtain the desired results.

As you can see, we set the page size in the driver equal to the graphics programs page size. We also selected "Add Shoulder" and "Normal Rubber Stamp". We did not choose "Print as Negative Image" or "Print as Mirror Image" because these switches are only used when printing a full sheet of stamps. For more details on how to use and set the other shoulder types for the "3D Effects" option, please refer to Section 3.

After making all driver selections, print the graphic to the laser system. Start engraving and watch the stamp engrave and cut in the correct position on the rubber sheet. The background area, since it is colored black is being engraved and the letters remain standing up. When the engraving part is done, the stamp gets cut out along the red cut line due to the stronger settings that were assigned in the driver for the color red.

### Full Sheet Method

The second method is to create a full sheet of rubber stamps and engrave them all at the same time. First create a stamp as a positive image as shown below.

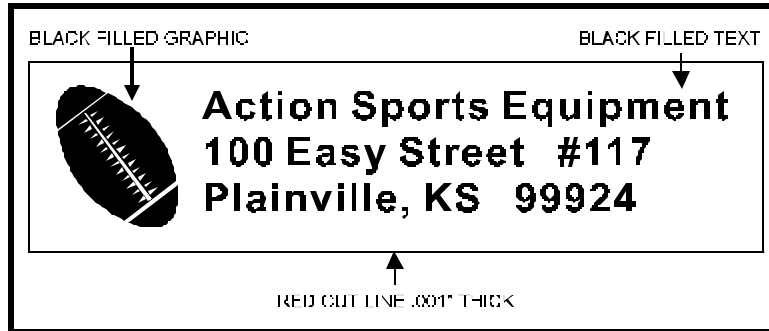

Create more stamps to fill the entire page. They can be the same stamp or different ones.

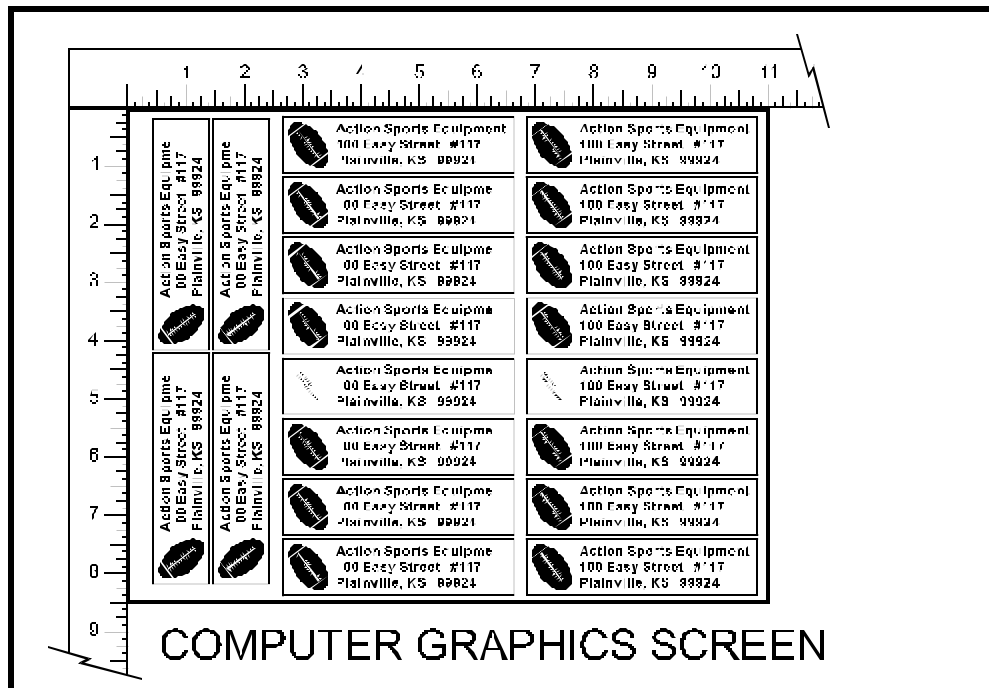

If desired, output the page to a paper printer for proofreading. Printing out a positive image to a printer is easier to read and uses less toner or ink than a negative print.

In the laser systems printer driver, use the same settings as the previous example but with only minor modifications. In the “3D Effects” tab, select all three “Special” options; “Add Shoulder”, “Print as Negative Image” and “Print as Mirror Image” as the diagram below illustrates.

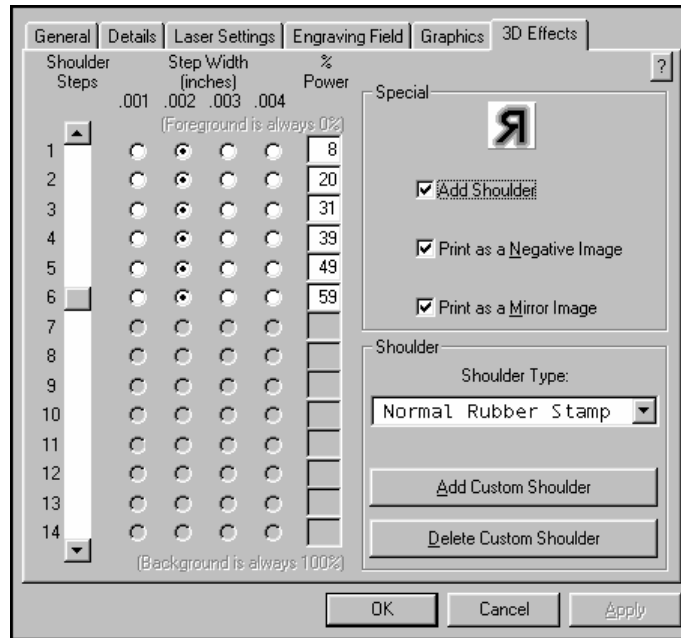

Print to the laser system. Position the full sheet of rubber stamp material in the same upper left location on the engraving table and begin engraving. The driver automatically adds the shoulder, mirrors the entire page, and creates a negative image for engraving, and cuts out the stamps.

## Rotary Fixture

The Rotary Fixture has been designed to engrave cylindrical objects. Two attachments come with the fixture, a cone shaped disk attached to the motorized end of the fixture and an inverted cone shaped disk attached to the adjustable end of the fixture. These attachments are used to hold wineglasses, mugs, cups, etc.

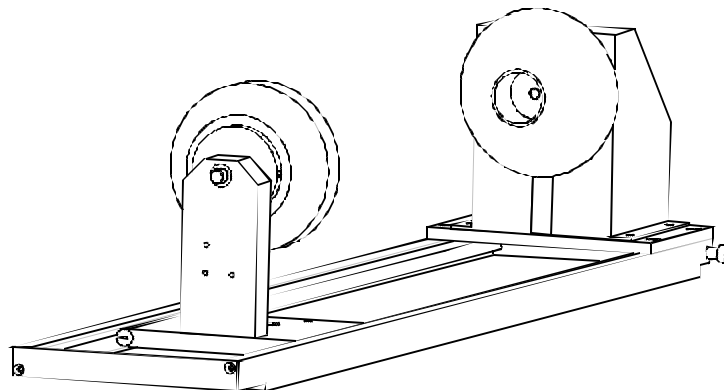

## 7-6 Options & Accessories

---

The Rotary Fixture is placed on the engraving table as the following diagram illustrates.

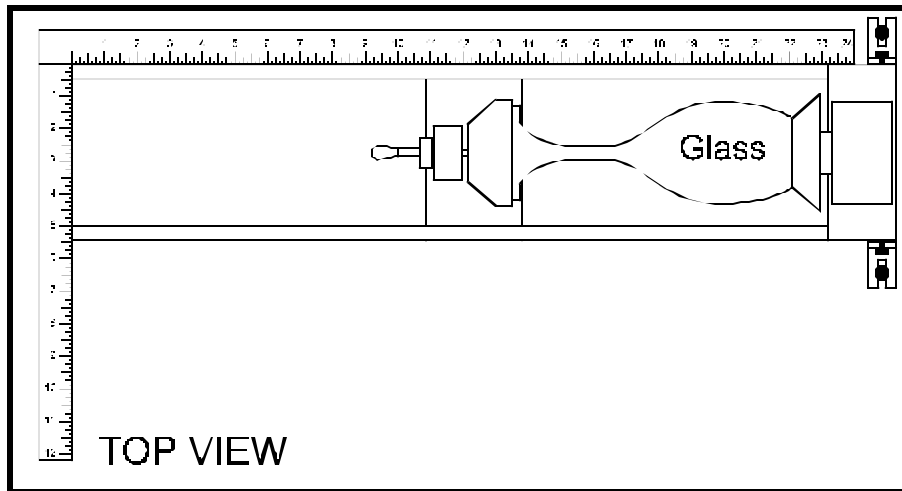

Please refer to the instructions supplied with the Rotary Fixture on how to properly install and use this option.

## Cutting Table

The purpose of the Cutting Table is to support the material that you are cutting off of the engraving table's surface to minimize surface contact area. It also redirects exhaust airflow below and above the material for better smoke removal. The Cutting Table is installed directly on top of the engraving table. It is composed of a sheet metal box, alignment rulers, and a replaceable honeycomb style bed. The honeycomb material is reflective only in the area that contacts your material to minimize laser beam reflection.

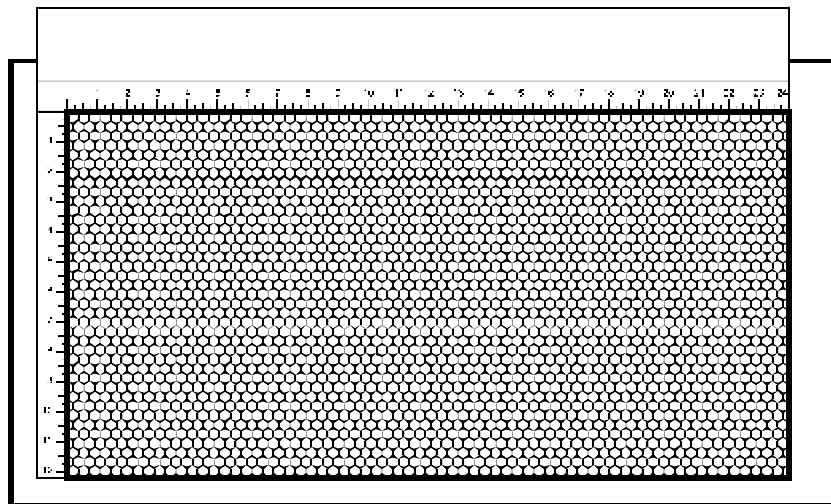

Please refer to the instructions supplied with the Cutting Table on how to properly install and use this option.



## Air Assist System

The Air Assist System consists of a nozzle that attaches to the focus carriage, Optics protection adapters, tubing, mounting brackets, needle valve, and pressure gauge. The purpose of this system is to force air or other types of gases directly onto the surface of your material to reduce the burning effects of the laser beam and helps disperse the smoke and gases created when cutting or engraving materials. The optics protection parts assist in helping keep the optics cleaner from flying debris created from the pressurized nozzle. Use of this system requires a minimum compressed air source capable of 50 PSI @ 2.5 cfm. This supply **MUST** be free from oil, water, and particulate matter. Another option called the "Air Assist Compressor", can supply this source. The Air Assist System is truly a unique option that is a must for serious laser system production.

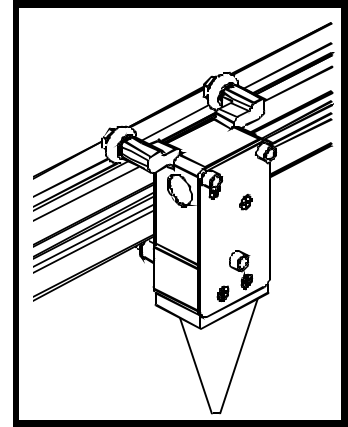

Please refer to the instructions supplied with the Air Assist System on how to properly install and use this option.

## Air Assist Compressor

The Air Assist Compressor option is a 50 PSI @ 2.5 cfm source for oil-free, water-free, and particulate matter-free compressed air. It contains a sound insulated air compressor, water dryer (desiccant), and coalescent particulate filter. This compact and custom designed unit is a great compliment to the Air Assist System option.

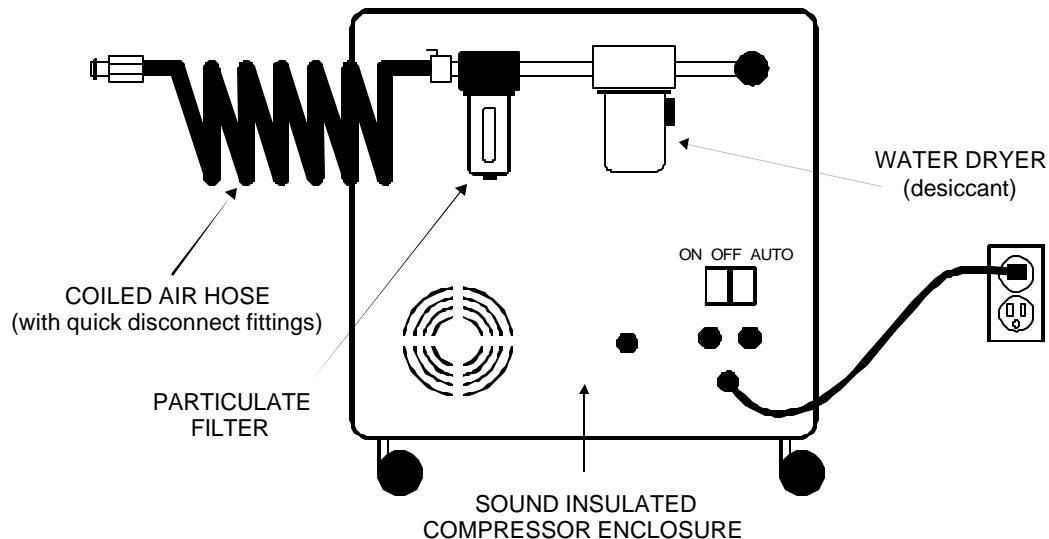

Please refer to the instructions supplied with the Air Assist Compressor on how to properly install and use this option.

## Focus Lens Kits

There are three optional Focus Lens Kits available other than the standard 2.0", they are the 1.5", 2.5", and the 4.0" kits. Included in these kits are the focus lens, #3 mirror, front plate, thumbscrews, and a focus tool.

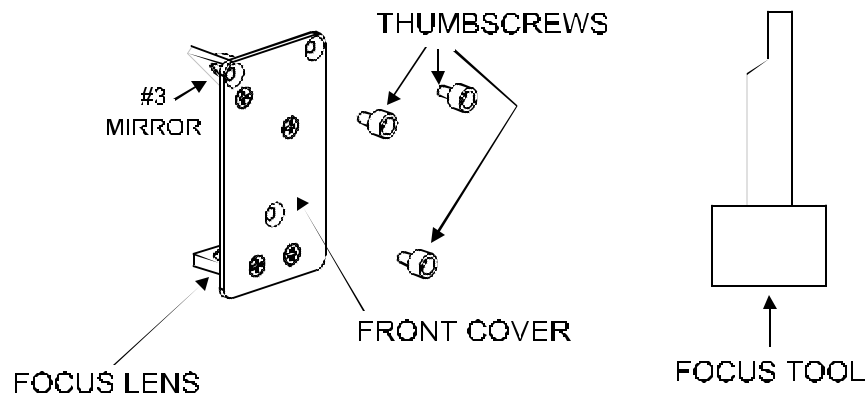

Different lenses produce different spot sizes and have different focal ranges. For example, the 1.5" lens produces a spot size of .003" and has an effective focal range of +/- .075". This lens can engrave very fine detail but can only be used on very flat materials. On the opposite end, the 4.0" lens has a spot size of .013" but has an effective focal range of +/- .2". Although this lens cannot engrave very fine detail, its focal range allows you to engrave on slightly rounded or curved objects without the need for rotation. Using a baseball as an example, focus the beam halfway between the highest point and the lowest point of engraving. Since a 4.0" lens has a greater focal range than a shorter lens, you can engrave a considerable distance around the ball without having to rotate it. Attempting to engrave further around the ball will result in a loss of engraving power and a distorted image.

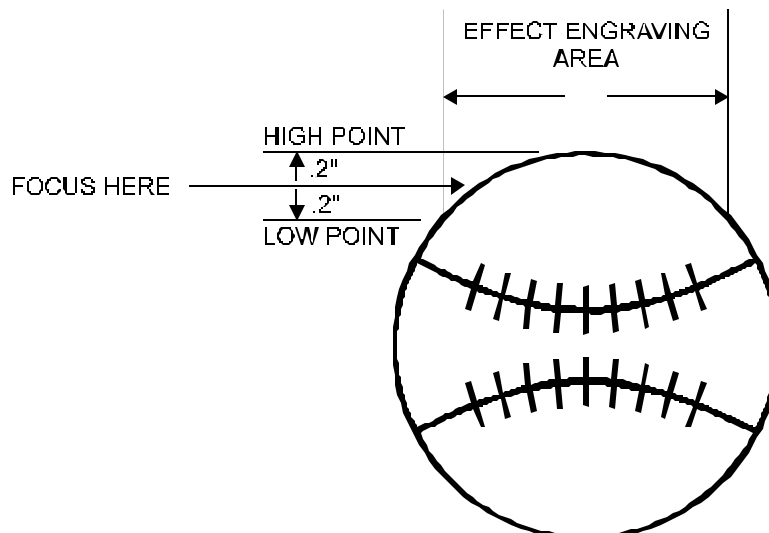

Refer to the following chart for spot sizes and focal ranges of the lenses available.

<b>FOCAL LENGTH</b>	<b>SPOT SIZE</b>	<b>FOCAL RANGE</b>
1.5 "	.003 "	+ / - .075 "
2.0 "	.005 "	+ / - .100 "
2.5 "	.007 "	+ / - .125 "
4.0 "	.013 "	+ / - .200 "

If you would like to order any of the accessories described in this section, please speak with your salesperson or call us directly to place an order or to get current pricing. Most of these items are in stock and are available for immediate shipment.

---

**SECTION 8**

# Sample Materials

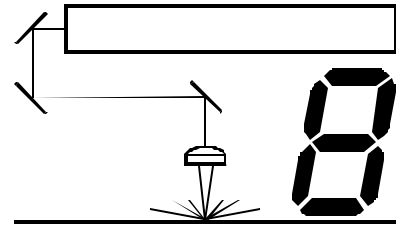

This section provides sample driver settings and helpful hints to get started engraving and/or cutting the materials listed.

## Safety



**NEVER LEAVE THE LASER SYSTEM RUNNING UNATTENDED FOR ANY REASON.** Exposure to the laser beam can cause ignition of combustible materials. All laser cutting and engraving should be constantly supervised.

**NEVER OPERATE THE LASER SYSTEM WITHOUT A PROPERLY INSTALLED AND OPERATING EXHAUST SYSTEM.** Some materials when cut or engraved can produce fumes that are hazardous in concentrated amounts. Also make sure that your room is adequately ventilated as some materials will continue to produce fumes for several minutes to possibly hours after the cutting or engraving process has been completed. Since many materials can produce toxic and possibly caustic fumes or residue, it is advisable to obtain the Material Safety Data Sheet (MSDS) from the materials manufacturer. The MSDS discloses all of the hazards when handling or processing that material. The law requires all manufacturers to provide this information to anyone who requests it.

**DO NOT ENGRAVE OR CUT PVC (Polyvinylchloride) BASED MATERIALS.** The fumes are extremely toxic if you inhale them. The fumes are so caustic that it can chemically destroy the metal parts of the laser system. Damage to the laser system from this type of abuse **WILL NOT** be covered under warranty.

**DO NOT ENGRAVE OR CUT UNCOATED METALS OR REFLECTIVE SURFACES.** The laser beam can reflect off of these materials causing damage to the laser system as well as being a safety hazard. Damage to the laser system from this type of abuse **WILL NOT** be covered under warranty.

## NOTICE

Laser engraving or cutting materials other than those described in this manual can be a safety hazard and can damage the laser system.

The laser system operator is liable for any damages caused, in whole or in part, for any economic loss, physical injury, lost revenue, lost profits, lost savings or other indirect, incidental, special or consequential damages incurred.

Damages to the laser system due to neglect, misuse, or operator error WILL NOT be covered under warranty.

## Materials

There are many variables that can affect the cutting and engraving process such as differences in the thickness of the material, density of the material, composition of the material, and the manufacturing processes used to make the material. Please use these settings as a guideline, in most cases these settings should work out well, but sometimes may have to be adjusted to produce desirable results.

### PRINTER DRIVER SETTING TIPS

#### Power Setting

- Higher burns deeper. Too much power sacrifices detail. Has no effect on running time.
- Lower burns shallower. Too little power sacrifices detail. Has no effect on running time.

#### Speed Setting

- Higher saves time. Burns shallower and reduces detail.
- Lower increases time. Burns deeper but too deep may reduce detail.

#### PPI Setting

- Higher increases the burning or melting effect. Produces finer detail if Speed is not too fast. Has no effect on running time and very little effect on depth.
- Lower decreases the burning or melting effect. Reduces image detail if set too low. Has no effect on running time and very little effect on depth. Very low settings are used to perforate the material.

#### Rule of Thumb

- Doubling the Power doubles the depth and halving the Power halves the depth.
- Halving the Speed doubles the depth and doubling the Speed halves the depth.

## NOTE

The M15, M20, and M25 run at a maximum raster speed of 40 inches per second. The M30 and M35 run at a maximum raster speed of 50 inches per second. This is why the settings between the M25 and the M30 are the same. Since the M30 has 5 more watts and runs 10 inches per second faster than the M25, the effects cancel each other out resulting in the same depth of engraving. The advantage is that the total engraving time is reduced. When engraving very small objects, top speed cannot be achieved because acceleration and deceleration of the motion system requires time and distance. The laser system will automatically adjust itself to a maximum engraving speed that it can achieve due to the size and position of the graphic. This is why you might notice that there might be no difference in engraving time on certain graphics whether you choose 100% speed or less.

The following materials were tested with the laser system set at 500 DPI except where noted otherwise. The following pages will fully describe the results of these tests and will offer helpful hints when choosing materials, setting parameters, and using different techniques to provide the best laser cutting and engraving results.

### ACRYLIC - CAST AND EXTRUDED

ACRYLIC – MIRRORED

ALUMINUM – ANODIZED

BRASS – PAINTED

CORK

CORIAN / AVONITE / FOUNTAINHEAD

DELRIN (SEAL PRESS)

GLASS / CRYSTAL

LEATHER

MARBLE

MAT BOARD

MELAMINE

PLASTIC – MICROSURFACED

RUBBER STAMPS

VINYL – SIGN (3 MIL)

WOOD / WOOD INLAY

---

**ACRYLIC - CAST AND EXTRUDED**
**LIGHT RASTER ENGRAVING**

LASER WATTAGE	POWER	SPEED	PPI	PASS	DEPTH
15	65	100	500	1	.001"
20	50	100	500	1	.001"
25	40	100	500	1	.001"
30	33	80	500	1	.001"
35	29	80	500	1	.001"

**COMMENTS:** Remove original factory masking from the engraving surface. Leave the masking on the non-engraved surface to prevent accidental scratches.

**DEEP RASTER ENGRAVING**

LASER WATTAGE	POWER	SPEED	PPI	PASS	DEPTH
15	100	27	500	1	.010"
20	100	36	500	1	.010"
25	100	45	500	1	.010"
30	100	45	500	1	.010"
35	100	53	500	1	.010"

**COMMENTS:** This sample engraved deeper than the first sample. Engrave through original masking. Engraving too deep will lose detail.

**VECTOR ENGRAVING**

LASER WATTAGE	POWER	SPEED	PPI	PASS	DEPTH
15	8	4.0	1000	1	.010"
20	6	4.0	1000	1	.010"
25	5	4.0	1000	1	.010"
30	4	4.0	1000	1	.010"
35	3	4.0	1000	1	.010"

**COMMENTS:** Engrave with or without masking.

**VECTOR CUTTING**

LASER WATTAGE	POWER	SPEED	PPI	PASS	DEPTH
15	100	.4	1000	1	.2"
20	95	.5	1000	1	.2"
25	75	.5	1000	1	.2"
30	63	.5	1000	1	.2"
35	54	.5	1000	1	.2"

**COMMENTS:** For the best results, remove the original masking on both sides. Re-mask with transfer tape. Moisten both sides with water from a spray bottle. Elevate the material at least 1/2" off of the engraving table to reduce table reflection damage to the backside of the material.

## ADDITIONAL COMMENTS

There are two types of acrylic available, cast and extruded. Cast turns white or frosted and extruded remains clear when engraved. Use extruded acrylic for paint filled engraving and cast for regular engraving. Cast engraves better without masking. Lightly engrave the surface to frost it with a low power setting such as the first setting listed above. If deep engraving is desired, it is necessary to mask the acrylic with transfer tape to prevent the smoke from damaging the clear surface of the acrylic. However, another problem with deep acrylic engraving is that the intense heat creates a white, crusty, deposit that accumulates along the edges of the area that was just engraved and is impossible to remove without causing damage. Engraving lightly and without masking seems to be the better all around alternative.

If only cutting acrylic, extruded works better and is less expensive than cast. The cut edges of extruded acrylic will appear to be more highly polished and clearer than cast acrylic when laser cut. When cutting acrylic, it might be necessary to remove both sides of the original masking and re-mask with transfer tape if cutting through the original masking produces flaming. The original masking is coated with wax and will not absorb water. If cutting through very thick acrylic, re-mask both sides with transfer tape and dampen the masking on both sides of the acrylic with water from a spray bottle. Elevate the acrylic off the table at least 1/2 inch, re-focus, and then proceed to cut. Elevating the acrylic will allow the beam to completely pass through the material which allows the smoke and heat to escape from underneath. If cutting directly on the engraving table, the trapped heat might cause the bottom edge of the cut to pit and distort. Re-masking and dampening with water will act as a heat sink to pull the laser heat away from the cutting area resulting in less distortion or heat effected zones (HAZ). When dampening, be sure not to leave puddles of water. Puddles of water will reduce cutting depth significantly. For the best results when combining engraving and cutting on the same piece, first engrave lightly and unmasked. Then mask with transfer tape, dampen, elevate, re-focus, and cut as a second step.

Paint filling the engraved area is possible by first masking the acrylic or leave on the original masking then engraving through the masking. Before removing the masking, brush or spray on some acrylic based or water based paint right on to the masking. When the paint is dry, remove the masking and the paint will remain in the recessed area of the engraving. Remember to use extruded acrylic when paint filling and cast acrylic when simply engraving.



**Acrylic is extremely flammable. Do not leave the laser system unattended when cutting or engraving.**



---

**ACRYLIC - MIRRORED**
**LIGHT RASTER ENGRAVING**

LASER WATTAGE	POWER	SPEED	PPI	PASS	DEPTH
15	75	100	500	1	.003"
20	57	100	500	1	.003"
25	45	100	500	1	.003"
30	37	80	500	1	.003"
35	32	80	500	1	.003"

**COMMENTS:** Engrave unmasked and on the backside in reverse text. Engraving on the front side of mirrored acrylic will visually produce a double image.

**DEEP RASTER ENGRAVING**

LASER WATTAGE	POWER	SPEED	PPI	PASS	DEPTH
15	100	27	500	1	.010"
20	100	36	500	1	.010"
25	100	45	500	1	.010"
30	100	45	500	1	.010"
35	100	53	500	1	.010"

**COMMENTS:** Masking is not necessary because the acrylic is protected from smoke damage by the mirrored backing.

**VECTOR ENGRAVING**

LASER WATTAGE	POWER	SPEED	PPI	PASS	DEPTH
15	13	4.0	500	1	.010"
20	10	4.0	500	1	.010"
25	8	4.0	500	1	.010"
30	7	4.0	500	1	.010"
35	6	4.0	500	1	.010"

**COMMENTS:** Again, masking is not necessary because the acrylic is protected from smoke damage by the mirrored backing.

**VECTOR CUTTING**

LASER WATTAGE	POWER	SPEED	PPI	PASS	DEPTH
15	100	.8	1000	1	.1"
20	95	1.0	1000	1	.1"
25	75	1.0	1000	1	.1"
30	63	1.0	1000	1	.1"
35	54	1.0	1000	1	.1"

**COMMENTS:** Make sure both sides are masked. Dampen and elevate at least 1/2" above the engraving table. Two passes make a cleaner cut than one. Cut from the front side of the mirror to prevent heat distortion of the mirrored back surface.

## ADDITIONAL COMMENTS

Engraving mirrored acrylic is similar to engraving regular acrylic. The idea is to engrave through the mirrored backing enough to begin to penetrate into the acrylic. Engraving deeply will cause a crusty residue to form just like with non-mirrored acrylic. A double image will appear if engraving on the front side of the mirror. It is not necessary to mask the backside when engraving because the mirrored backing shields the acrylic from smoke damage. To cut mirrored acrylic, it might be necessary to remove all original masking, re-mask with transfer tape, and dampen the tape with water from a spray bottle. Next, place the acrylic in the laser with the mirrored surface facing upwards and elevate at least 1/2 inch above the table. The laser beam will not reflect off of the mirrored surface because it is absorbed by the acrylic first. Sometimes cutting the acrylic from the backside will cause the mirrored backing to distort and crack from the intense heat required to cut. If the combination of engraving and cutting is desired, our suggestion is to engrave the backing, unmasked, remove the acrylic, mask both sides with transfer tape, flip the acrylic over, dampen, elevate, re-focus, and cut from the front side. When paint filling the engraved area, make sure to use an acrylic-based paint or paint that does not contain acetone or alcohol, as these chemicals will crack the acrylic. Water based paints also work very well. Since the mirrored backing serves as a masking, it is not necessary to mask the backside before engraving.

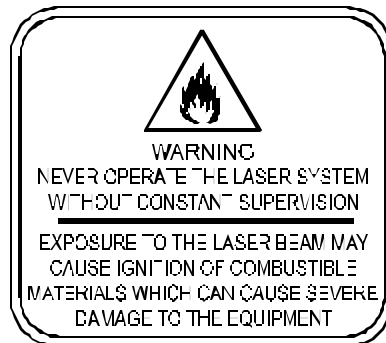

**Acrylic is extremely flammable. Do not leave the laser system unattended when cutting or engraving.**

**ANODIZED ALUMINUM**

**RASTER ENGRAVING**

LASER WATTAGE	POWER	SPEED	PPI	PASS	DEPTH
15	70	100	500	1	.001"
20	55	100	500	1	.001"
25	45	100	500	1	.001"
30	37	80	500	1	.001"
35	32	80	500	1	.001"

**COMMENTS:** The power required is dependent on the thickness of the anodized coating. Do not overpower because the anodized will either be dull in appearance or the engraving lines will be too thick.

**VECTOR ENGRAVING**

LASER WATTAGE	POWER	SPEED	PPI	PASS	DEPTH
15	25	4.0	1000	1	.001"
20	18	4.0	1000	1	.001"
25	15	4.0	1000	1	.001"
30	13	4.0	1000	1	.001"
35	11	4.0	1000	1	.001"

**COMMENTS:** Different anodized coatings will require higher or lower power settings. Power must be increased if engraving at a faster speed.

**ADDITIONAL COMMENTS**

There is a process called Laser Color Marking which enables the color filling of anodized aluminum. First, coat or spray the aluminum with a clear acrylic finish. After the finish has thoroughly dried, laser engrave the graphic onto the aluminum. Then take a water based marker, such as those found in an art supply store, and swab on the ink into the engraved area. You can actually see the ink get absorbed into the engraved area but not the unengraved area. The ink will appear lighter in color because the white engraved area tends to lighten the shade. Use a darker tint marker to compensate for the lighter effect. Wipe off the excess with a soft, lint free cloth. Finish the piece by applying another coat of clear acrylic finish and let dry.



**DO NOT ATTEMPT TO ENGRAVE DEEPLY OR CUT THIS MATERIAL WITH THE LASER SYSTEM.** High Power and low Speed settings can cause the laser beam to reflect off of this material which can damage the laser system and can be a safety hazard. Damage caused by this type of abuse **WILL NOT** be covered under warranty.



**ENGRAVING THIS MATERIAL PRODUCES ABRASIVE PARTICLES.** Clean the laser system more frequently to reduce wear and tear on the motion system components and optics. Damage to the laser system from inadequate or insufficient maintenance **WILL NOT** be covered under warranty.



**BRASS - PAINTED****RASTER ENGRAVING**

LASER WATTAGE	POWER	SPEED	PPI	PASS	DEPTH
15	70	100	1000	1	.002"
20	55	100	1000	1	.002"
25	45	100	1000	1	.002"
30	37	80	1000	1	.002"
35	32	80	1000	1	.002"

**COMMENTS:** Engrave unmasked. Use a light setting to **ONLY** remove the paint.

**VECTOR ENGRAVING**

LASER WATTAGE	POWER	SPEED	PPI	PASS	DEPTH
15	42	4.0	1000	1	.002"
20	31	4.0	1000	1	.002"
25	25	4.0	1000	1	.002"
30	21	4.0	1000	1	.002"
35	18	4.0	1000	1	.002"

**COMMENTS:** Engrave unmasked. Use a light setting to **ONLY** remove the paint.

**ADDITIONAL COMMENTS**

The manufacturing processes for coated brass varies from one vendor to another. Some of the manufacturers do not polish the brass before coating it. Since CO<sub>2</sub> lasers at this power level do not engrave into metals when the coating is removed, the tarnished brass underneath will have a dull appearance that will need to be polished with a brass polishing compound. This type of brass is designed for mechanical engravers that actually remove the metal when engraving which gives the brass a shine without polishing. Brass that is produced for the laser engraving industry is polished, then clear coated, and finally coated with paint. When laser engraving this type of material, adjust the power so that the laser beam removes the painted coating but not the clear coating. This will expose the polished, clear-coated brass without penetrating all the way down to the metal. Since the brass is already clear coated and polished, it will not require any cleanup after engraving nor will it ever oxidize. If too much laser power is used, the brass the clear coat will be removed and the brass underneath will be exposed to the heat of the laser beam causing instant tarnish. If polishing the brass, use a soft, non-abrasive cloth or tissue and good quality brass polish. Be careful not to rub too hard, as this will scratch the painted coating. Do not use paper towels either because they will scratch also. Clear-coated brass can also be engraved and the engraved area turned black with an oxidizer giving exceptional results. If the brass, after being engraved, does not oxidize with the acid solution, apply automotive fine grit rubbing compound to the engraved area with a soft cloth. This will remove any clear coat that is remaining and will allow the brass to oxidize with the acid. Apply the same parameters and engraving techniques when using coated aluminum.



**DO NOT ATTEMPT TO ENGRAVE DEEPLY OR CUT THIS MATERIAL WITH THE LASER SYSTEM.** High Power and low Speed settings can cause the laser beam to reflect off of this material which can damage the laser system and can be a safety hazard. Damage caused by this type of abuse **WILL NOT** be covered under warranty.

## CORIAN / AVONITE / FOUNTAINHEAD

**RASTER ENGRAVING**

LASER WATTAGE	POWER	SPEED	PPI	PASS	DEPTH
15	100	27	500	1	.007"
20	100	36	500	1	.007"
25	100	45	500	1	.007"
30	100	45	500	1	.007"
35	100	53	500	1	.007"

**COMMENTS:** Mask first before engraving if planning to paint fill.

**DEEP RASTER ENGRAVING**

LASER WATTAGE	POWER	SPEED	PPI	PASS	DEPTH
15	100	14	500	1	.015"
20	100	18	500	1	.015"
25	100	23	500	1	.015"
30	100	23	500	1	.015"
35	100	27	500	1	.015"

**COMMENTS:** Mask first if planning to paint fill.

**VECTOR ENGRAVING**

LASER WATTAGE	POWER	SPEED	PPI	PASS	DEPTH
15	83	4.0	500	1	.010"
20	62	4.0	500	1	.010"
25	50	4.0	500	1	.010"
30	42	4.0	500	1	.010"
35	36	4.0	500	1	.010"

**COMMENTS:** Mask first if planning to paint fill.

**ADDITIONAL COMMENTS**

Laser engraving this type of material produces spectacular results especially when the engraved area is paint filled. If paint filling, it is a good idea to mask first and then engrave through the masking. In this way, when ready to paint fill, the material is already masked. Spray painting seems to be the easiest. Using a paintbrush is acceptable but time consuming. Use the paint sparingly. Excess paint can accumulate on the edges of the engraving, which will make mask removal difficult and leave unsightly ridges. It is best to apply several lighter coats than one heavy coat of paint. Remove the masking after the paint has dried. Engraving this material without paint filling can work but most of the time there is very little contrast which makes the engraved area difficult to see.



**ENGRAVING THIS MATERIAL PRODUCES ABRASIVE PARTICLES.** Clean the laser system more frequently to reduce wear and tear on the motion system components and optics. Damage to the laser system from inadequate or insufficient maintenance **WILL NOT** be covered under warranty.

## CORK

**RASTER ENGRAVING**

LASER WATTAGE	POWER	SPEED	PPI	PASS	DEPTH
15	100	50	500	1	.010"
20	100	67	500	1	.010"
25	100	83	500	1	.010"
30	95	80	500	1	.010"
35	85	80	500	1	.010"

**COMMENTS:** Engraved unmasked.

**VECTOR ENGRAVING**

LASER WATTAGE	POWER	SPEED	PPI	PASS	DEPTH
15	17	4.0	500	1	.010"
20	13	4.0	500	1	.010"
25	10	4.0	500	1	.010"
30	8	4.0	500	1	.010"
35	7	4.0	500	1	.010"

**COMMENTS:** Engrave unmasked.

**VECTOR CUTTING**

LASER WATTAGE	POWER	SPEED	PPI	PASS	DEPTH
15	83	1.6	100	1	.060"
20	63	1.6	100	1	.060"
25	50	1.6	100	1	.060"
30	42	1.6	100	1	.060"
35	30	1.6	100	1	.060"

**COMMENTS:** Unmasked. A low PPI setting is used to prevent flaming.

**ADDITIONAL COMMENTS**

Cork is not very popular for engraving but it does engrave and cut nicely. Cork is mainly used for making gaskets by vector cutting the gasket patterns.



**LASER CUTTING THIS MATERIAL CAN CAUSE FLAMING AND SPARKING.** Use caution when attempting to cut this material. It would be better to use a longer focal length lens to prevent the lens from being damaged during processing. **NEVER** leave the machine unattended while processing any material. Damages caused by processing any material **WILL NOT** be covered under warranty.

**DELTRIN (SEAL PRESS)**

**RASTER ENGRAVING**

LASER WATTAGE	POWER	SPEED	PPI	PASS	DEPTH
15	100	23	500	1	.015"
20	100	30	500	1	.015"
25	100	38	500	1	.015"
30	100	38	500	1	.015"
35	100	44	500	1	.015"

**COMMENTS:** Engraved unmasked.

**VECTOR CUTTING**

LASER WATTAGE	POWER	SPEED	PPI	PASS	DEPTH
15	75	1.5	200	1	.060"
20	75	1.9	200	1	.060"
25	75	2.4	200	1	.060"
30	75	2.4	200	1	.060"
35	75	2.8	200	1	.060"

**COMMENTS:** Unmasked. A low PPI setting is used to prevent flaming.

**ADDITIONAL COMMENTS**

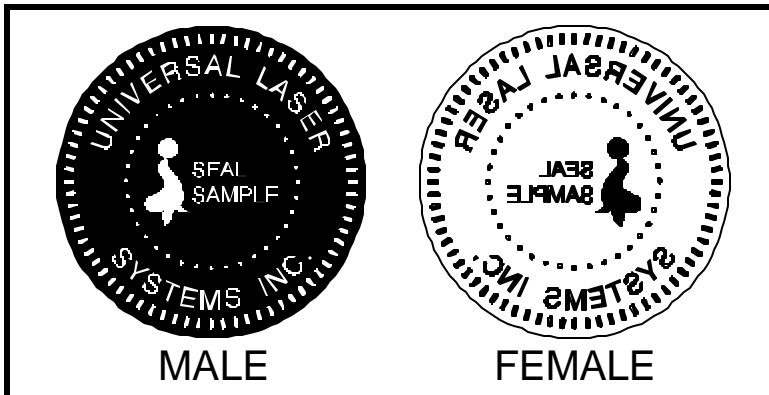

The laser system can be used to make dies for seal presses. It can engrave and cut out a typical Notary Seal in less than 5 minutes. Create the male with a white graphic and a black background. Mirror the image and invert it by making the background white and the graphic black. Add a .010 inch black outline to the graphic portion of the female side. This will give the greater clearance to

the female side to prevent the paper from piercing through when the male side of the seal presses into the female side. Once the seal is made and fastened to the press, make several impressions onto 400 grit sandpaper to smoothen out the edges of the plastic. Make sure you turn the sandpaper over to get both sides of the seal.



**LASER CUTTING THIS MATERIAL CAN CAUSE FLAMING.** Use caution when attempting to cut this material. Make sure that the flame does not come in contact with any part of the laser system. **NEVER** leave the machine unattended while processing any material. Damages caused by processing any material **WILL NOT** be covered under warranty.



## GLASS / CRYSTAL

**RASTER ENGRAVING**

LASER WATTAGE	POWER	SPEED	PPI	PASS	DEPTH
15	100	42	300	1	.001"
20	100	32	300	1	.001"
25	100	25	300	1	.001"
30	100	25	300	1	.001"
35	100	21	300	1	.001"

**COMMENTS:** Spreading out the laser pulses (reducing PPI) and overlap (reducing DPI to 333) reduces chipping. Higher DPI and PPI creates too much heat and can chip or shatter the glass.

**VECTOR ENGRAVING**

LASER WATTAGE	POWER	SPEED	PPI	PASS	DEPTH
15	25	4.0	300	1	.001"
20	18	4.0	300	1	.001"
25	15	4.0	300	1	.001"
30	13	4.0	300	1	.001"
35	11	4.0	300	1	.001"

**COMMENTS:** Since glass will not vaporize, it does not require much laser power.

**ADDITIONAL COMMENTS**

Glass engraving is different from other types of engraving. A CO<sub>2</sub> laser cannot engrave into the glass nor can it cut glass. Instead, laser interaction with glass causes the surface of the glass to appear frosted. Sometimes, placing a piece of newspaper on the glass and dampening it with water will improve the appearance of the engraving. Another method is to apply transfer tape to the glass, wet it with water from a spray bottle, and laser engrave it. The transfer tape and water will act as a heat sink and pull the heat away from the glass as the laser system engraves it. This helps reduce chipping or flaking of the glass.

Be especially careful when engraving leaded crystal. The lead in crystal conducts heat, which can cause much more flaking or even the cracking of the crystal. Use a lower power setting to try to reduce the chance of damage. It is always good to have at least one extra piece to use as a test piece to get the right settings especially if you have never tried to engrave that material before.



**ENGRAVING THIS MATERIAL PRODUCES ABRASIVE PARTICLES.** Clean the laser system more frequently to reduce wear and tear on the motion system components and optics. Damage to the laser system from inadequate or insufficient maintenance **WILL NOT** be covered under warranty.

---

**LEATHER**
**LIGHT RASTER ENGRAVING**

LASER WATTAGE	POWER	SPEED	PPI	PASS	DEPTH
15	53	100	500	1	.001"
20	40	100	500	1	.001"
25	32	100	500	1	.001"
30	27	80	500	1	.001"
35	23	80	500	1	.001"

**COMMENTS:** Engrave unmasked.

**VECTOR ENGRAVING**

LASER WATTAGE	POWER	SPEED	PPI	PASS	DEPTH
15	8	4.0	500	1	.003"
20	6	4.0	500	1	.003"
25	5	4.0	500	1	.003"
30	4	4.0	500	1	.003"
35	3	4.0	500	1	.003"

**COMMENTS:** Engrave unmasked.

**VECTOR CUTTING**

LASER WATTAGE	POWER	SPEED	PPI	PASS	DEPTH
15	100	1.5	200	1	.1"
20	100	2.0	200	1	.1"
25	80	2.0	200	1	.1"
30	67	2.0	200	1	.1"
35	57	2.0	200	1	.1"

**COMMENTS:** Mask top surface and use a low PPI setting when cutting.

**ADDITIONAL COMMENTS**

Leather is a very simple material to engrave and most types of leather engrave very well with the laser system. Simulated leather engraves well also, but the results are not as nice as with the real thing. Engraving lightly will turn the surface of the leather dark brown giving it a high contrast in appearance. Try engraving at a light power setting first. If the result is not deep enough the job can be run again over the same spot. Experiment with different depths of engraving and note the results.

**MARBLE****LIGHT RASTER ENGRAVING**

LASER WATTAGE	POWER	SPEED	PPI	PASS	DEPTH
15	100	37	500	1	.003"
20	100	50	500	1	.003"
25	100	62	500	1	.003"
30	100	62	500	1	.003"
35	100	72	500	1	.003"

**COMMENTS:** Engrave unmasked. Gives the appearance of a frosted image.

**DEEP RASTER ENGRAVING**

LASER WATTAGE	POWER	SPEED	PPI	PASS	DEPTH
15	100	12	500	1	.010"
20	100	17	500	1	.010"
25	100	21	500	1	.010"
30	100	21	500	1	.010"
35	100	24	500	1	.010"

**COMMENTS:** Engrave unmasked. Gives the appearance of a frosted image.

**VECTOR ENGRAVING**

LASER WATTAGE	POWER	SPEED	PPI	PASS	DEPTH
15	33	4.0	500	1	.003"
20	25	4.0	500	1	.003"
25	20	4.0	500	1	.003"
30	17	4.0	500	1	.003"
35	14	4.0	500	1	.003"

**COMMENTS:** Engrave unmasked. Gives the appearance of a frosted image.

**ADDITIONAL COMMENTS**

Most marble and polished stones will turn white when engraved. Masking is not necessary and light engraving works out better than heavy and deep engraving. Engraving deeply will cause a highly detailed image to appear washed out. The objective is to engrave deep enough to turn the marble white and provide a good contrast. Too much power can also cause the material to discolor and turn brown as if it were burned. Photographs look great when engraved on marble, especially darker marbles where the whiteness of the engraving really stands out. Avoid using marble that is very textured looking. The texture washes out the details of the engraving. Try to use uniformly colored marble and related stones. Marble can also be paint filled by using a wax based paint. Rub the paint on with a fingertip, let dry and then buff with a soft cloth. The paint will only adhere to the engraved surface and not the surrounding areas.



**ENGRAVING THIS MATERIAL PRODUCES ABRASIVE PARTICLES.** Clean the laser system more frequently to reduce wear and tear on the motion system components and optics. Damage to the laser system from inadequate or insufficient maintenance **WILL NOT** be covered under warranty.

---

**MAT BOARD**
**RASTER ENGRAVING**

LASER WATTAGE	POWER	SPEED	PPI	PASS	DEPTH
15	67	100	250	1	.005"
20	50	100	250	1	.005"
25	40	100	250	1	.005"
30	33	80	250	1	.005"
35	28	80	250	1	.005"

**COMMENTS:** Engrave unmasked and at a low PPI setting to prevent discoloration.

**VECTOR ENGRAVING**

LASER WATTAGE	POWER	SPEED	PPI	PASS	DEPTH
15	33	4.0	250	1	.005"
20	25	4.0	250	1	.005"
25	20	4.0	250	1	.005"
30	17	4.0	250	1	.005"
35	14	4.0	250	1	.005"

**COMMENTS:** Engrave unmasked and at a low PPI setting to prevent discoloration.

**VECTOR CUTTING**

LASER WATTAGE	POWER	SPEED	PPI	PASS	DEPTH
15	100	4.0	200	1	.050"
20	75	4.0	200	1	.050"
25	60	4.0	200	1	.050"
30	50	4.0	200	1	.050"
35	43	4.0	200	1	.050"

**COMMENTS:** Mask on both sides and elevate above the table at least 1/8". Use a lower PPI setting to reduce discoloration of the cutting edge.

**ADDITIONAL COMMENTS**

Mat board (thick cardboard) is an excellent material to use for architectural modeling and for picture framing. It cuts and engraves very neatly and cleanly. It comes in a variety of shades and colors. Patterns can be engraved on the surface with a power setting for light engraving which just breaks through the very thin top layer and exposes the lighter colored underlying substrate. When engraving, a low PPI setting is used to prevent overexposure of the underlying substrate material, which causes excessive dark discoloration. Masking is not necessary on the top surface when engraving. When cutting, both sides might need to be masked and the material elevated above the engraving table. This will produce an extremely clean edge on both sides of the material.

---

**MELAMINE - STANDARD ENGRAVING**
**LIGHT RASTER ENGRAVING**

LASER WATTAGE	POWER	SPEED	PPI	PASS	DEPTH
15	100	75	500	1	.015"
20	100	56	500	1	.015"
25	100	45	500	1	.015"
30	100	45	500	1	.015"
35	100	53	500	1	.015"

**COMMENTS:** Engrave unmasked.

**DEEP RASTER ENGRAVING**

LASER WATTAGE	POWER	SPEED	PPI	PASS	DEPTH
15	100	53	500	1	.020"
20	100	40	500	1	.020"
25	100	32	500	1	.020"
30	100	32	500	1	.020"
35	100	37	500	1	.020"

**COMMENTS:** Engrave unmasked.

**VECTOR ENGRAVING**

LASER WATTAGE	POWER	SPEED	PPI	PASS	DEPTH
15	33	4.0	500	1	.010"
20	25	4.0	500	1	.010"
25	20	4.0	500	1	.010"
30	17	4.0	500	1	.010"
35	14	4.0	500	1	.010"

**COMMENTS:** Engrave unmasked.

**ADDITIONAL COMMENTS**

Engraving melamine is very similar to engraving regular wood with the added benefit of a consistent surface finish and uniform base material composition. Unlike regular wood that has grain patterns and density variations, melamine, when laser engraved, produces a flat and even engraved area. This characteristic gives this material superior engraving and paint filling qualities. Masking can be used if desired but it is just as easy to spray the engraved area with water and wipe down with a chamois cloth to remove the smoke residue. Since the top surface material is consistent in texture and color, engraving photographs or highly detailed images produces exceptional results. Refer to the next example on engraving photographs and/or ClipArt.

---

**MELAMINE - PHOTO/CLIPART ENGRAVING**
**RASTER ENGRAVING**

LASER WATTAGE	POWER	SPEED	PPI	PASS	DEPTH
15	100	50	500	1	.008"
20	100	68	500	1	.008"
25	100	85	500	1	.008"
30	95	80	500	1	.008"
35	82	80	500	1	.008"

**COMMENTS:** Engrave unmasked. Use a resolution of 500 DPI.

**RASTER ENGRAVING**

LASER WATTAGE	POWER	SPEED	PPI	PASS	DEPTH
15	100	25	500	1	.008"
20	100	34	500	1	.008"
25	100	43	500	1	.008"
30	100	43	500	1	.008"
35	100	50	500	1	.008"

**COMMENTS:** Engrave unmasked. Use a resolution of 250 DPI.

**ADDITIONAL COMMENTS**

Engraving photographs can be challenging at first but becomes easier once there is an understanding of what to look for and how to achieve the desired results. In an image processing software, scan the image in at 300 DPI. Adjust the brightness and the contrasts to brighten the light colors and darken the dark colors. The photo might look better by using a sharpening filter to sharpen up the image slightly. The next step is to select a halftone pattern. Usually, imaging software gives the choice of using different halftone patterns including frequency of lines per inch and pattern angles. Use a line frequency above 20 and below 100. The size of the dots decreases as the line frequency increases. Experiment to see which pattern looks the best. Big dots look good on some materials and small dots look better on others. If it is not possible to assign a halftone pattern in the imaging software, the printer driver will automatically default to a predetermined pattern based on **RESOLUTION**. When using the Clipart mode switch, which prints all Clipart or drawings as grayscale bitmaps, use the same parameters and techniques as for engraving photographs. Please refer to Section 3 about using predefined halftone screens in the driver or creating custom ones.

## PLASTIC - ENGRAVERS MICROSURFACED

### RASTER ENGRAVING

LASER WATTAGE	POWER	SPEED	PPI	PASS	DEPTH
15	67	100	500	1	.003"
20	50	100	500	1	.003"
25	40	100	500	1	.003"
30	33	80	500	1	.003"
35	29	80	500	1	.003"

**COMMENTS:** Remove original masking and leave unmasked. Use enough power to remove the surface material and expose the underlying substrate.

### VECTOR CUTTING

LASER WATTAGE	POWER	SPEED	PPI	PASS	DEPTH
15	100	1.0	150	1	.060"
20	75	1.0	150	1	.060"
25	60	1.0	150	1	.060"
30	50	1.0	150	1	.060"
35	43	1.0	150	1	.060"

**COMMENTS:** Remove original masking. Mask with transfer tape on both sides. Dampen both sides with water and elevate off the table.

## ADDITIONAL COMMENTS

Laser engraveable plastic comes in many different colors, thickness, coatings, and surface textures. Most engravers plastic will engrave and cut well with the laser system as long as it is microsurfaced and formulated for laser engraving. Removal of large amounts of material will warp the plastic. You might need to tape it down or hold it down flat somehow to prevent it from curling as you engrave. Since these plastics have low melting point, a low PPI setting is used when cutting to reduce the possibility of melting. Masking and dampening with water also helps to reduce melting and keeps the plastic clear of smoke residue. Always remove the original clear masking from the plastic because it does not react well with the laser. Since there are so many types of engravers plastics, the only true way to find out if a particular brand and type will work well with the laser is to experiment. Use these power settings as a guideline for experimentation and adjust as necessary. Thicker top coated plastics are not recommended because it requires too much power to remove the material and the large amount of smoke created usually stains the substrate.



**LASER ENGRAVING OR CUTTING PLASTIC CAN IGNITE THE MATERIAL.** Never leave the laser system running unattended for any reason.

**RUBBER STAMPS**

***RASTER ENGRAVING***

LASER WATTAGE	POWER	SPEED	PPI	PASS	DEPTH
15 (Not recommended)	N/A	N/A	N/A	N/A	N/A
20 (Not recommended)	N/A	N/A	N/A	N/A	N/A
25	100	20	500	1	.030"
30	100	24	500	1	.030"
35	100	28	500	1	.030"

**COMMENTS:** Different blends and densities of rubber will engrave to different depths. Test the rubber first to determine the correct power settings.

***PERFORATED VECTOR CUTTING***

LASER WATTAGE	POWER	SPEED	PPI	PASS	DEPTH
15 (Not recommended)	N/A	N/A	N/A	N/A	N/A
20 (Not recommended)	N/A	N/A	N/A	N/A	N/A
25	50	1.6	90	1	.040"
30	50	1.6	90	1	.040"
35	50	1.8	90	1	.040"

**ADDITIONAL COMMENTS**

To create a rubber stamp, use the “3D Effects” tab in the driver (Section 3). In the above example, only one pass is necessary to achieve a deeply engraved rubber stamp. When cutting out the rubber stamp, we recommend using a very low PPI setting. This setting spreads the laser pulses far enough apart that they just touch at the edges. The result is a perforated cut that allows the rubber stamp to remain attached to the entire sheet but easily removed by simply tearing it off. The advantage to this is that the possibility of distortion or melting while cutting is virtually eliminated and the entire sheet of rubber stamps can be removed from the machine at one time instead of having to pick them up one by one.



- **LASER ENGRAVING OR CUTTING RUBBER CAN IGNITE THE MATERIAL.** Never leave the laser system running unattended for any reason.
- **LASER ENGRAVING OR CUTTING RUBBER CAN PRODUCE FOUL ODORS.** You might need to particulate filter and/or odor filter your exhaust depending on your environment, installation location, and/or your local air quality control laws.
- **LASER ENGRAVING OR CUTTING RUBBER PRODUCES ABRASIVE DUST.** Clean the laser system more frequently to reduce wear and tear on the motion system components and optics. Damage to the laser system from inadequate or insufficient maintenance **WILL NOT** be covered under warranty.



## SIGN VINYL

**RASTER ENGRAVING**

LASER WATTAGE	POWER	SPEED	PPI	PASS	DEPTH
15	100	18	500	1	.015"
20	100	24	500	1	.015"
25	100	30	500	1	.015"
30	100	30	500	1	.015"
35	100	35	500	1	.015"

**COMMENTS:** These parameters are for engraving vinyl on wood.

**VECTOR CUTTING (KISS CUT)**

LASER WATTAGE	POWER	SPEED	PPI	PASS	DEPTH
15	5	2.4	500	1	.003"
20	5	3.2	500	1	.003"
25	5	4.0	500	1	.003"
30	5	4.8	500	1	.003"
35	5	5.6	500	1	.003"

**COMMENTS:** Unmasked, cuts through vinyl and not the backing. Thicker vinyl requires more power and thinner ones require less. Adjust as necessary.

**ADDITIONAL COMMENTS**

Sign vinyl comes in a wide variety of colors, patterns, thickness, finishes, and reflectivity. There are a few methods for using sign vinyl with the laser system. One method is to vector cut (unmasked) through the vinyl but not through the backing. This technique provides results equivalent to a vinyl cutter machine. Once the vinyl has been cut, remove the excess vinyl, apply transfer tape and use a squeegee to remove trapped air bubbles. The transfer tape can then be lifted off and the vinyl lettering or objects that were vector cut will stick to the transfer tape and maintain their correct spacing with respect to each other. Now apply the tape to the desired surface and squeegee, peel off the transfer tape, and the lettering will remain adhered to the surface. The other method is to apply a piece of vinyl to the desired surface (unmasked) and adjust the laser power so as to cut through the vinyl without engraving into the material below. Another popular example of the use of vinyl is to cover the entire surface of a wooden plaque with vinyl, use a squeegee to remove all air bubbles, and then mask the entire surface with transfer tape to protect the vinyl from smoke damage due to the wood engraving involved. In the graphics software, color the background black and place white filled text on top of the colored background. Since the laser system does not engrave white filled objects, the background will be engraved and the lettering will be untouched. Then peel off the excess vinyl and transfer tape to reveal the final product. The lettering will be raised and vinyl coated.



**MOST SIGN VINYL IS MADE FROM PVC (Polyvinylchloride). DO NOT USE PVC BASED VINYL.** The fumes are extremely toxic if you inhale them. The fumes are also caustic and can chemically destroy the metal parts of the laser system. Damage to the laser system from this type of abuse **WILL NOT** be covered under warranty.

---

**WOOD**
**RASTER ENGRAVING**

LASER WATTAGE	POWER	SPEED	PPI	PASS	DEPTH
15	100	27	500	1	.020"
20	100	36	500	1	.020"
25	100	45	500	1	.020"
30	100	45	500	1	.020"
35	100	53	500	1	.020"

**COMMENTS:** Engrave unmasked

**VECTOR ENGRAVING**

LASER WATTAGE	POWER	SPEED	PPI	PASS	DEPTH
15	25	4.0	500	1	.030"
20	19	4.0	500	1	.030"
25	15	4.0	500	1	.030"
30	13	4.0	500	1	.030"
35	11	4.0	500	1	.030"

**COMMENTS:** Engrave unmasked

**VECTOR CUTTING**

LASER WATTAGE	POWER	SPEED	PPI	PASS	DEPTH
15	83	1.6	300	1	.125"
20	63	1.6	300	1	.125"
25	50	1.6	300	1	.125"
30	50	1.9	300	1	.125"
35	50	2.2	300	1	.125"

**COMMENTS:** Elevate at least 1/8" off of the engraving table. Lightly dampen bottom side with water. Both surfaces can also be masked and dampened with water. Elevating will let heat and smoke escape from underneath and prevent burning.

**ADDITIONAL COMMENTS**

When engraving wood with a laser, a brown, maple syrup like residue will deposit on the surface of the wood. This is normal and impossible to eliminate by **POWER**, **SPEED**, or **PPI** changes. More residue will be present when engraving deeper and/or slower. This residue washes off with water and a sponge. We recommend using a kitchen sponge with a nylon string mesh wrapped around it. Dampen the sponge and wipe off the residue. A damp chamois cloth works well also. Do not use paper towels or a regular sponge because these materials will get lodged in the engraved area when wiping and are extremely difficult to remove. A method to avoid cleanup is to mask the wood with transfer tape and peel off the tape after engraving. If desired, after engraving and before peeling off the tape, spray paint can be applied to color fill the engraved areas. After the paint dries, peel off the tape. If an intricate drawing has been engraved and there are many small pieces of tape to remove, it may

be easier to flood the masking, after engraving, with water. This will loosen the tape and it can be easily removed by rubbing it off by hand. In the vector cutting example, the wood was elevated from the table to let smoke and heat escape from underneath. If elevating the wood, mask and/or dampen the bottom side of the wood very lightly and the water acts as a heat sink to prevent the underside from flaming and charring. Elevating the wood also helps to determine whether the laser has passed completely through since the cut pieces will fall through to the table when cutting is finished. If raising the wood, set up the drawing so that the inner pieces of the drawing are cut first, otherwise pieces may fall through at the wrong time.

Not all wood finishes are created equal. When ordering wood from a supplier, be sure to specify that it is being used for laser engraving. Some finishes cannot handle the heat from the laser and will bubble, blister, and possibly turn white. For engraving softer woods such as pine or balsa, reduce the power settings to acquire the best depth. Engraving too deep on soft woods will reduce quality. Every type of wood will engrave differently. Experiment with different types of wood and note the results. It is better to engrave woods that are finished. If engraving unfinished wood and it is not masked with transfer tape, the smoke residue tends to embed in the wood and is impossible to remove without sanding. To prevent this, mask all unfinished wood with transfer tape.

### **WOOD INLAYS - VENEERS**

Create a drawing with no outlines, only filled areas. Engrave the filled areas almost as deep as the thickness of the veneer (usually about .003 inches (.1 mm) or less). With some water and a nylon brush, remove all residue from the engraved area. When cutting veneers make sure they are lying absolutely flat. In the drawing, give the objects an outline of .001 inches (.1 mm) and remove the fill. Adjust the power so that there is just enough power to cut completely through the veneer. Overpowering the cut will cause too much material removal and the fit will not be snug. Some software programs allow outline offsetting to compensate for the thickness of the beam. This is called contouring and is optimal if planning to do this type of work. Usually, a contour to the outside of the vector line of .006 inches provides a tight fit. Remember, if using more power to cut through the veneer, compensate for the thicker width of the laser cut by contouring a little further to the outside.

Another method, which we believe is a better way, is to first create your graphic and fill it with the color black. Then give it a white outline of .012 inches (.3 mm). If you look at the graphic when you add the outline, you will see that it appears to shrink. Now raster engrave the graphic to a depth slightly shallower than the thickness of the veneer. When the engraving is finished, place the veneer into the laser system. Take the graphic on screen, remove the black fill and change the outline to the color red. Also make sure that the red outline thickness is set to .001 inches (.1 mm) so that it will vector cut. Cut out the veneer with the laser system, add glue to the veneer, and apply the veneer into the engraved area of the other piece of wood and let dry. After the glue has thoroughly dried, sand the veneer until it is flush with the base wood. A good veneer to use is one with an adhesive backing. Once cut, place the veneer into its proper place on the engraved wood block and with a clothes iron, and iron the veneer into the engraved wood. This melts the glue and causes the veneer to stick to the engraved area. Finish the wood as you desire and the finished product will look fantastic. The veneer can now be sanded flush with the surface and a finish coat applied.

## SECTION 9

# Maintenance

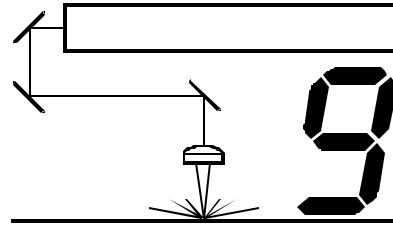

Keeping the laser system clean will ensure the highest quality engraving. The frequency of cleaning will depend entirely on the type of material being engraved, the performance of your exhaust blower, the operating environment, and the amount of laser system usage over a given period of time. Dirt or debris that is allowed to build up on the motion system components will cause uneven or rough engraving, or loss of engraving position as well as premature component failure. Smoke or dirt buildup on the optics can cause damage to them, loss of laser power, or premature failure of these components. Use good judgment and keep in mind that a clean machine is the best performing machine.



Always turn the laser engraving system OFF and unplug it before performing any cleaning procedures.

## Suggested Cleaning and Maintenance Supplies

- Soap solution mixture of 1 tablespoon (2 cl) liquid soap and 1 quart (liter) of water in a spray bottle
- Paper towels
- Cotton cloth
- Denatured alcohol (**NOT** to be used on any painted surface, plastic, or the Top Window)
- Acetone (can be used on the engraving table but nowhere else)
  
- Cotton swabs (supplied)
- Lens cleaner (supplied)
- Lens tissue (supplied)
  
- Vacuum cleaner
- Set of Allen wrenches sized from .050 to 3/16 inch

**\*NOTE:** When using acetone or denatured alcohol, please follow the instructions on the printed label of these materials for safe handling procedures.

Please familiarize yourself with the motion system components in the following diagram. It will help you understand which components need periodic cleaning.

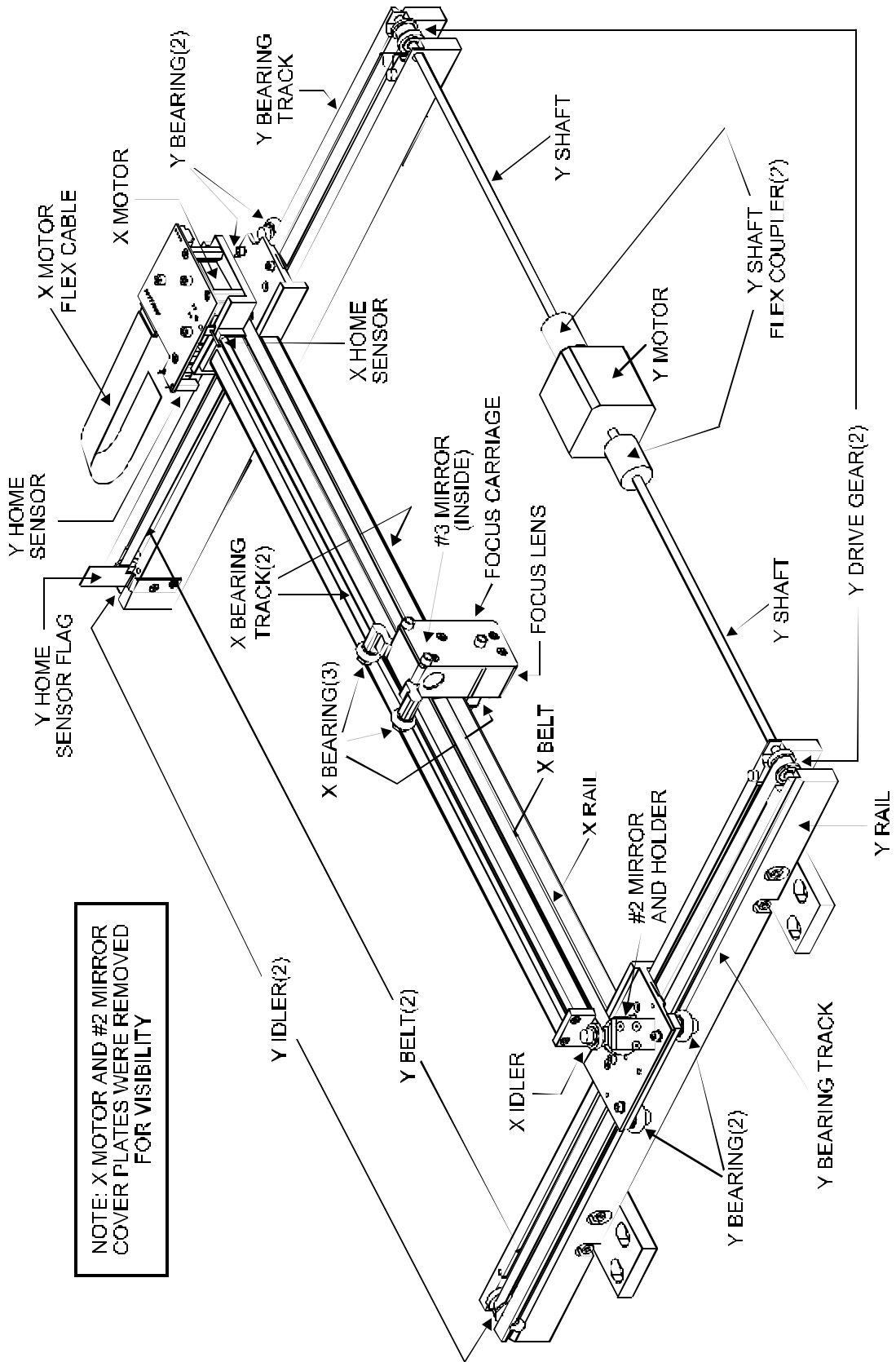

NOTE: X MOTOR AND #2 MIRROR COVER PLATES WERE REMOVED FOR VISIBILITY

## System Cleaning

- Turn off and unplug the laser system.
- Open the Top Door and thoroughly remove all loose dirt and debris from inside the machine with a vacuum cleaner.
- Clean the Engraving Table surface with either a soap solution, alcohol, or acetone, and paper towels. **NEVER** pour or spray any solution directly into the laser system. Always dampen your paper towel or cloth outside of the machine with the cleaning solution and then wipe down the parts you are cleaning with the dampened cloth.
- Clean X Rail and the Y Rails by using either the cotton swabs or paper towels, and alcohol or soap solution. Pay close attention to the bearing tracks that the bearings roll in since any debris left to build up in these bearing tracks will cause the bearings to wear and the engraving quality to become rough.
- After the rails and tracks are cleaned, use a clean swab or paper towel, and alcohol to clean all of the bearings by holding the swab against each bearing and moving the motion system by hand to roll the bearings against the swab. There are seven bearings in the system, three (3) on the Focus Carriage, two (2) on the left side of the X Rail, and two (2) on the right side of the X Rail.
- Clean the Top Window with a cotton cloth and the soap solution. The Top Window is made out of acrylic. **DO NOT** use paper towels because they will scratch the acrylic. Also, **DO NOT** use window cleaner, alcohol, or acetone, as these chemicals will crack the acrylic. Only use cleaners designed for acrylic.
- Use a soft cloth or paper towels and the soap solution to clean the enclosure. **DO NOT** use alcohol, acetone, or any other harsh chemical as this will damage the paint.

## Optics Cleaning

A visual inspection of the #2 and #3 Mirrors, Beam Window, and Focus Lens should be performed at least once a day.

### CAUTION

**DO NOT** clean an optic that is visually clean. Excessive cleaning can damage the optics. The #3 Mirror and the Focus Lens will need to be removed to clean them, the #2 Mirror and the Beam Window does not.

Before cleaning the optics, we recommend that you wash your hands thoroughly to prevent contamination. **NEVER** touch any optic with your fingers. The acids from your skin can destroy the coatings on the optics.

### #2 Mirror

To gain access to the #2 Mirror, the mirror cover must be removed. Remove the thumbscrew, slide the cover to the right slightly and lift straight up.

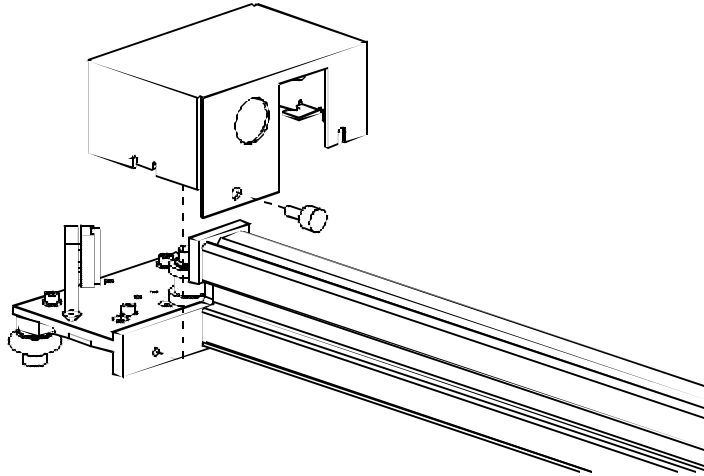

Inspect the #2 Mirror and clean it only if there is debris present. There are two ways to clean the mirror, with a moistened cotton swab or a moistened lens tissue.

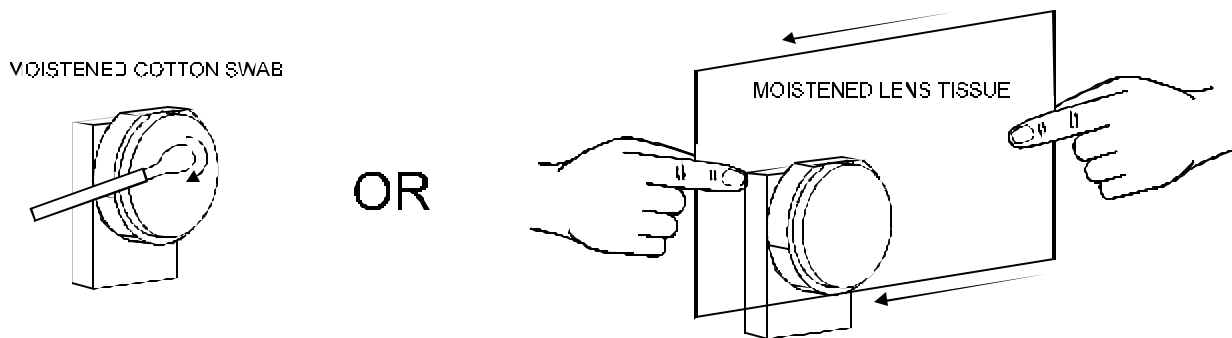

To clean the #2 Mirror with a cotton swab, moisten the cotton swab with the Lens Cleaning solution supplied with the laser system. **DO NOT** use other types of cleaners or solutions. Gently roll the cotton swab across the mirror once. **DO NOT** drag the swab or roll it back and forth as this can scratch the mirror. If the mirror did not come clean, use a fresh cotton swab and repeat the procedure. Do not worry about small pieces of lint that come off of the cotton swab. They will be vaporized as soon as the laser hits it. You can cause more damage to the mirror by trying to get it off than by leaving it alone.

The other method is to use a piece of lens tissue and the Lens Cleaning solution. Place a drop of solution onto the lens tissue. Grasp the tissue by the edges and drag the moistened tissue across the #2 mirror in one direction. If the #2 mirror does not come clean in the first attempt, repeat the procedure with a fresh piece of moistened lens tissue. **DO NOT** re-use the same lens tissue twice and **DO NOT** put any finger pressure on the surface of the mirror as this can scratch it.

**#3 Mirror and Focus Lens**

You must remove the front cover to the Focus Carriage to gain access to the #3 Mirror and the Focus Lens. To do this, hold the front cover with one hand and with the other hand, remove the three(3) thumbscrews that attach the front cover to the Focus Carriage, and pull the front cover straight out. You will notice that the #3 Mirror and the Focus lens are both mounted to the front cover. Refer to the diagram below.

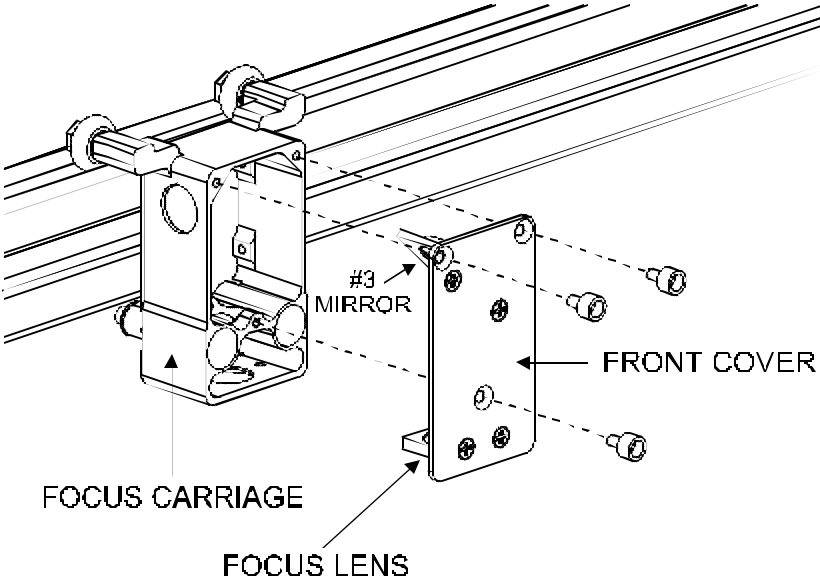

The #3 Mirror and the Focus lens are both glued to a metal bracket and the metal bracket is attached to the front plate with Phillips head screws. It is not necessary to detach the bracket from either optic in order to clean them. Simply tilt the front cover at enough angle so that you can apply the Lens Cleaning solution directly to the #3 Mirror and to the Focus Lens. Flood the surfaces with the solution. If heavy debris is present, let the solution soak in for a minute. Roll a fresh cotton swab across the #3 Mirror to dry it off. Remember that it is okay if a small amount of lint from the cotton swab remains on the mirror. Repeat this procedure for the Focus lens and always use a fresh swab.

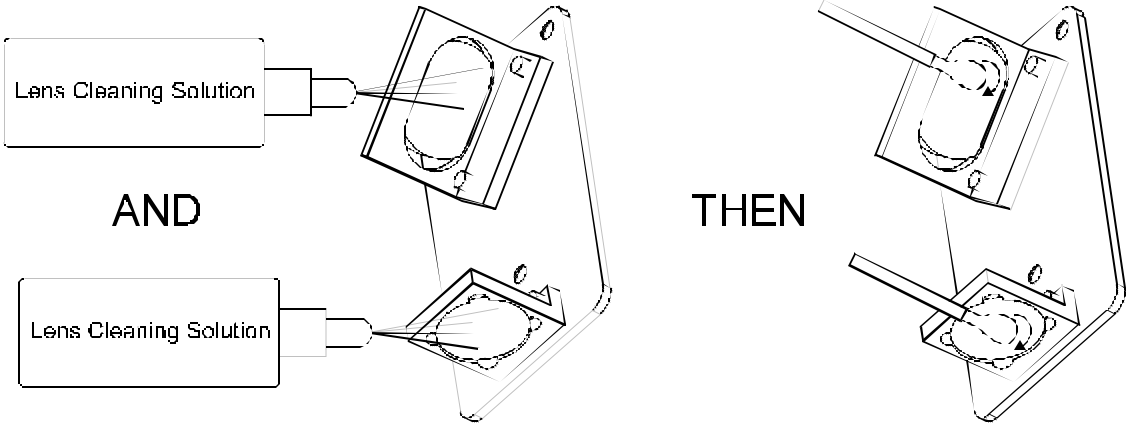



**Beam Window**

The Beam Window is where the laser beam enters into the engraving area. It is located in the upper left hand corner of the engraving area against the back wall and is yellow in color. It is not necessary to remove the Beam Window for cleaning since it can only get dirty on the front side. The backside is in a sealed environment. To clean the Beam Window, moisten a cotton swab and gently roll it across. Basically, clean it in the same manner as the #2 Mirror.

**AUTOFOCUS Sensor and Reflector (if installed)**

Engraving smoke can adhere to both the sensor and the reflector of the AUTOFOCUS system. If this happens, you will notice that when you turn AUTOFOCUS on and press the “Z” button, the engraving table will go all the way down to the bottom and get stuck. You will then need to call our service department so that we can assist you into getting the system back to normal operation. To prevent this problem from occurring, you should clean the sensor and reflector periodically. How often you clean them is dependent on the types of materials you are engraving and the quality of your exhaust system. The diagram below shows the locations of these parts.

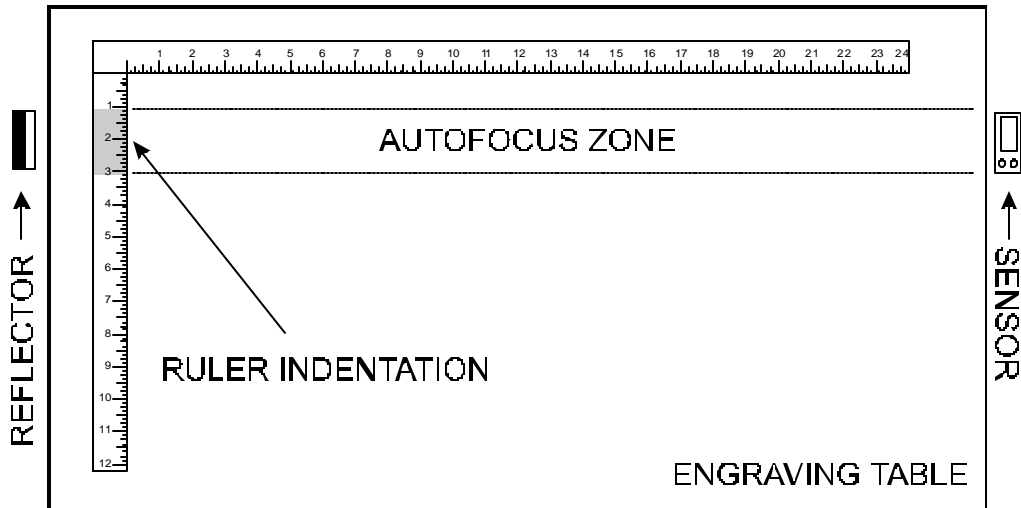

To clean these parts, dampen a soft cotton cloth with water and gently wipe across the reflective surface in one direction. DO NOT rub hard or create scratches in the plastic, otherwise the AUTOFOCUS system will malfunction. DO NOT use any type of cleaners, only use water or a very light solution of hand soap and water on the sensor or reflector.

You can observe if the sensor is working properly by lowering the table so that you have clear sight of the sensor and the reflector. Look at the sensor and notice that the green LED will illuminate. Pass your hand in front of the sensor and watch the red LED turn on as your hand passes through the path, and the red LED will turn OFF when your hand clears the path. Contact our service department if you have any other concerns about the operation or maintenance of the AUTOFOCUS system.

## Adjustments and Lubrication

There are no periodic adjustments required. The bearings in the motion system will self adjust to take up any clearances as they begin to wear. The belts are fiber reinforced and will not stretch under normal use so that periodic tension adjustment is not necessary. Optical alignment is not necessary because the laser and the #2 Mirror are fixed.

All bearings in the system are sealed and do not require lubrication. **DO NOT** lubricate the tracks that the bearings ride in. The only lubrication that may be required is the screw threads for the table lifting mechanism. After some time, contaminants can adhere to the lubricant, which can cause the engraving table to bind up or sound squeaky. If this is the case, wipe off the contaminated grease with a soft cloth and apply fresh white lithium grease to the screw threads. Run the table up and down to work in the fresh grease.

## Electronic Upgrading

The laser systems onboard computer is equipped with a special "Flash" upgrade technology. If the electronic operation of the system should ever require upgrading, it can be done electronically without the changing of any parts. The upgrade file gets downloaded from your computer to the laser system via the parallel port. This file is then run on the laser system and it only takes a few minutes. Once the file has completely run, the laser system will automatically restart and the new changes will take effect. For more specific details, please refer to the instructions that will accompany the flash disk.

## Fuse Replacement

### Europe and other countries

5 x 20 mm, Glass, time delay, 250V, 5A fuse, designed to IEC 127-2 sheet 3, and approved by a recognized European testing agency.

### USA

If a fuse must be replaced, use only the following type:

5 x 20 mm, Glass, time delay, 250V, 10A fuse, UL approved

## Battery Replacement

### CAUTION

There is a danger of explosion if the battery is incorrectly replaced. Replace the battery only with the same or equivalent type recommended by the battery manufacturer. Using an incorrect battery, recharging or disassembling the battery may present a danger due to fire or explosion. Dispose of used batteries promptly according to the local regulations.

## Cooling Fan Filters

This air-cooled laser system will require periodic cleaning of the cooling fan filters. Since ambient air is used to cool the laser tube, the air must be filtered before it enters the inside of the laser system otherwise dirt and dust can build up inside of the laser system and damage it. The contaminants reduce the laser system’s cooling ability and will cause the laser tube to overheat. An overheated tube will lose laser power during engraving and will eventually shut down completely. The laser tube has a built in safety mechanism that will shut the beam off before it can damage itself.

The cooling fan filters are located on the back of the laser system. Do not push the laser system all the way back against the wall because air needs to circulate behind the laser system. Since there is a variety of laser power options available for this class of laser system, the cooling fan filters may differ in appearance compared to your system. Regardless, you should remove and clean these filters at least once a week depending on you environmental conditions. Dirtier environments require more frequent cleanings.

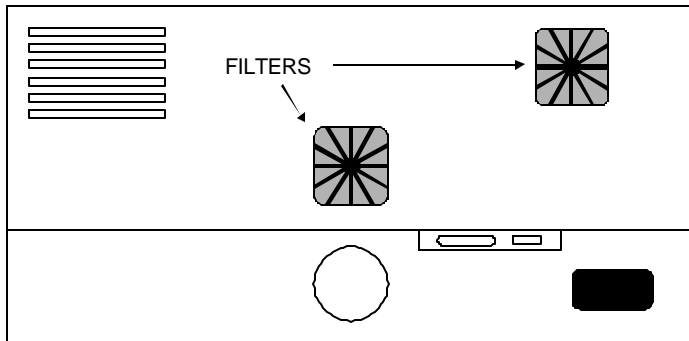

REAR OF LASER SYSTEM

To remove the filter(s), simply snap off the black cover and remove the foam element. Wash the element in a soap and water solution, dry, and re-install.



**NEVER OPERATE THE LASER SYSTEM WITH THE COOLING FAN FILTERS REMOVED.** This can permanently damage the laser system. Damage from this kind of abuse WILL NOT be covered under warranty.

## Maintenance Schedule

Since the maintenance requirements of the laser system is dependent on the type of material being run, the quantity of material being removed, the hours of operation, and the quality of the exhaust blower, it must be user defined. As a starting point, we recommend checking and, if necessary, cleaning the laser system after every 8 hours of engraving or cutting. Depending on your particular operation, you may need to adjust this schedule. If you are noticing a considerable buildup of debris on the optics and the motion system, clean the system at more frequent intervals. If your system has remained relatively clean, you can extend your cleaning intervals. You need to be the judge but keep in mind that a clean machine is a better performing machine and can extend the life of the parts as well as reduce the possibility of down time. Maintaining and cleaning the laser system should not take more than five (5) minutes a day. If you have any questions about maintaining the laser system, please contact our Service Department.



# APPENDIX

**Appendix A - Limited Warranty**

Please refer to the Warranty Registration Form included with your shipment.

## Appendix B - Specifications

Model Number M Class

Resolution	1000 x 1000 DPI, 500 x 500 DPI, 333 x 333 DPI, 250 x 250 DPI 200 x 200 DPI, Draft
Computer Interface	Windows 95, 98, and HPGL
Table Size	29" x 17" (736.6 mm x 431.8mm)
Work Area	24" x 12" (609.6 x 304.8 mm)
Maximum Part Size	29" (736.6mm) wide x 17" (431.8mm) deep x 9" (228.6mm) tall
Laser Source	15 watt air cooled CO2 laser quick change cartridge 20 watt air cooled CO2 laser quick change cartridge 25 watt air cooled CO2 laser quick change cartridge 30 watt air cooled CO2 laser quick change cartridge
Lenses Available	Focal Length / Spot Size / (Standard or Optional) 1.5" (38.1mm) / 0.003 inches (.08 mm) / Optional 2.0" (50.8mm) / 0.005 inches (.13mm) / Standard 2.5" (63.5mm) / 0.007 inches (.18 mm) / Optional 4.0" (101.6mm) / 0.013 inches (.33 mm) / Optional
Interfaces	Centronics parallel, RS232C Serial
Memory Buffer	Multiple file / Single file / Auto Start modes, automatic data compression
Dimensions	36" wide x 30" deep x 38.5" tall
Weight	200 lbs. (91 kg)
Safety	Class IIIa interlocked safety enclosure
Available Options	Rotary Fixture, Air Assist, Honeycomb Cutting Table

### **Facility Requirements**

Power	Single Phase 100/220V AC, 10/5 Amp, 50/60 Hz
Exhaust	Outside exhausting required, one 4" connection, 250 CFM minimum at 6 inches of static pressure (water)
Cooling	Air cooled (ambient temperature 58°F (15°C) to 85°F (30° C))

Specifications are subject to change without notice.

## Appendix C - Using DOS Based Programs

DOS software is not standardized and each application will work differently. When using DOS applications, it is not possible to print through the Windows Printer Driver and for this situation, the system has been designed to automatically emulate a Hewlett Packard plotter. Plotters use a special language called HPGL that the laser system has been designed to accept. When configuring the DOS based program, select the HP7475 plotter (or larger) as the printing device. Set the maximum paper size to 24 inches (609.6 mm) wide by 12 inches (304.8 mm) tall (refer to the DOS software manual for how to configure the printing device). Once configured properly, the laser system should interface with the program and act just like a plotter. Keep these points in mind:

1. Some DOS programs will not allow the page size to be set at 24 inches (609.6 mm) x 12 inches (304.8 mm) in the Landscape mode. If this is not possible, the full engraving field cannot be utilized. If a smaller page size is used, determine where the program will place the graphic on the engraving table by running a few tests.
2. Some DOS programs use the lower left corner of the engraving field as the origin so remember this when setting up the graphic drawing.
3. When assigning power settings to the graphic, it will be necessary to assign an HPGL plotter pen to the different colors in which the graphic was drawn. In most cases the pen numbers should match the power setting numbers in the laser systems "DOS Power Settings" display.
4. Some DOS programs may allow the setting of pen speed for the plotter pens. The laser will ignore these speeds. The laser system only recognizes the settings in the "DOS Power Settings" section of the laser systems control panel.
5. Set all of your line widths to .001 inch otherwise the laser system may go into raster mode instead of the desired vector mode.
6. If your laser system is configured to run in the multiple file memory mode, after every file download an "End of File" marker must be inserted at the laser systems control panel so that the memory control will work properly. To do this, print the file to the laser system and wait for the file to completely download. While in either the "MEMORY CONTROL" or the "FILE DISPLAY" menu, press and hold down the "NEXT FILE" button while you press the "SELECT" button once. Let go of both buttons and the word "NONAME" will appear in the display. You can now run the file. If you are in the "ONE FILE MEMORY" mode, it is unnecessary to do this because the file will run automatically as soon as the first part of the file enters into the laser systems memory.
7. Power setting for plotter pens can only be done at the laser system itself through the main control panel display. If having trouble with using DOS based programs, please contact our technical support.



## **Appendix D - Using Macintosh Computers**

The laser system has primarily been designed to run under the Windows 95 or Windows 98 operating system.

We have created the Macintosh printer driver to be used as a secondary computer operating system. This driver has limited features and capabilities compared with the PC driver.

If you ordered the Macintosh printer driver and the special printer cable required, please refer to the installation and operation instructions included with your order.

## Appendix E - Serial Port Cable Requirements

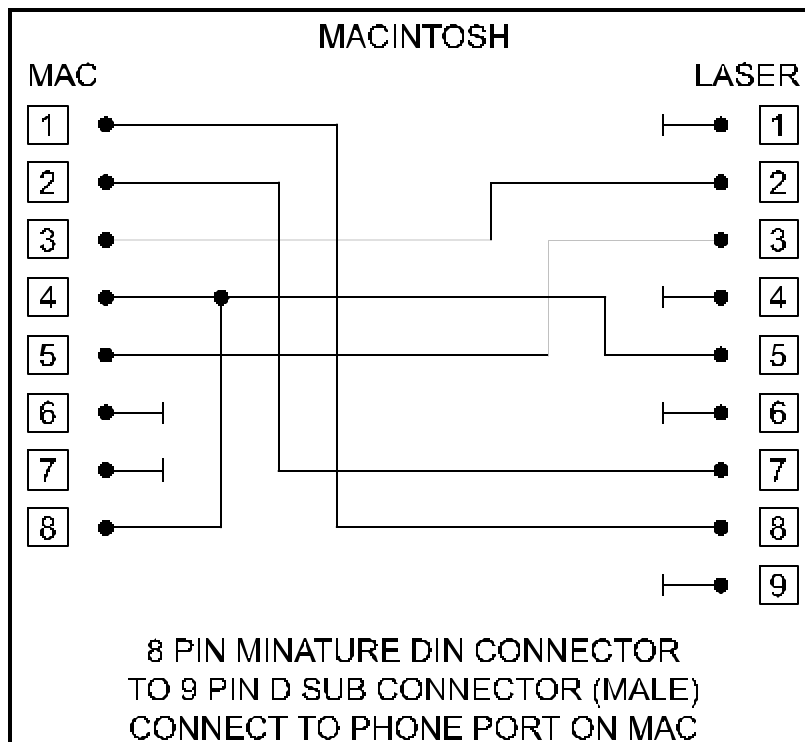
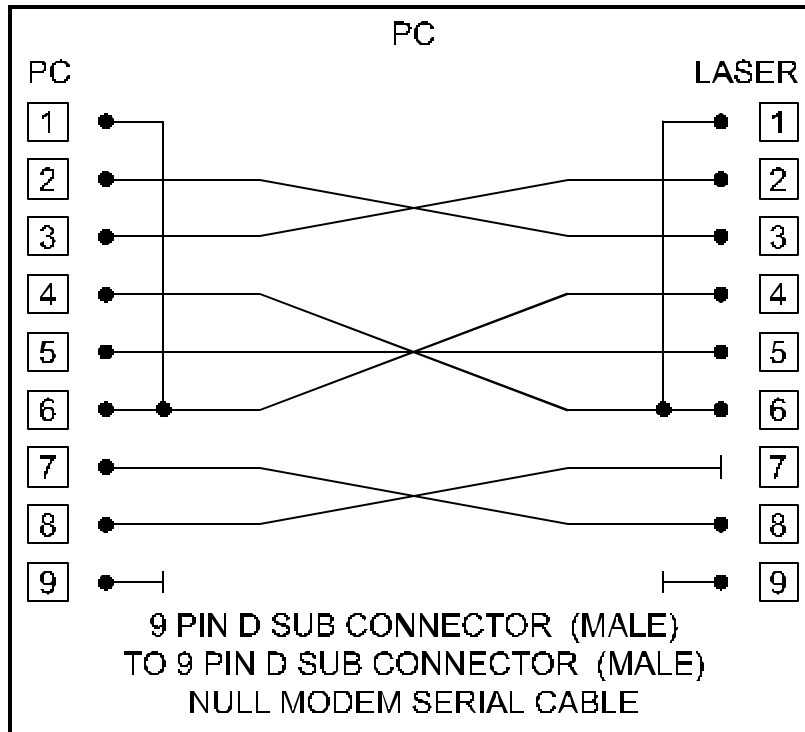

## Appendix F - Software Anomalies

In order for certain software to work properly with your laser system, some modifications might have to be made. If using the following software, be sure to follow these instructions. If having any difficulty making these adjustments, please contact our technical support.

### CorelDraw

- **Change a setting in one of CorelDraw's ini files.** If you are using any version of CorelDraw, you need to change the Fontrasterizer setting to "0" (zero). Corel's interpretation of fonts can sometimes be different than what Windows had intended the font to be. This is why we must turn off Corel's internal rasterizer and allow Windows to rasterize the fonts. A symptom would be fonts that print like black blocks. Another symptom would be that the font engraves scrambled when it is "Fitted to Path" and mirrored even though it looks good on screen. To learn how to change this setting go to Corel's help menu on screen and search for "Fontrasterizer" (without the quotes). It will tell you how to disable this setting.
- **If using Corel 8.0, you must change a setting in its default configuration.** Corel 8.0 uses, as its default, the Pantone color, display palette. This causes a problem with our driver's power setting, color mapping ability. A symptom of this would be an incorrect power setting being downloaded to the laser. For example, if you draw an object using what you think is the color "Red", Corel 8.0 actually tells our printer driver that it is the color "Orange" and uses the laser power settings that you defined in the driver for the color "Orange". Obviously, this will not produce the results that you desire. To fix this problem, you must first start Corel 8.0. Start a new graphic then click on the "Tools" menu. Then click on "Options", double click on "Global", click on "Color Management". Now deselect "Calibrate Colors for Display" so that there is NO check mark in the box. Click on "OK" and watch your screen colors change immediately.
- **Use the CorelDraw color palette that is found on your laser system's printer driver disk.** If you do not know how to set up your color palette to match the printer driver's color mapping feature, you can load the file called ULS.CPL into your CorelDraw's configuration. This palette can be used in versions 4,5,6,7, and 8. Color palette setup is described in more detail in Section 3 of this manual.
- **Set your line widths to the smallest possible size (in inches) to enable the laser system to vector.** In versions like Corel 4, you need to set the line width to .001 inches to enable the laser system to vector that line. In Corel 8, you need to set it to .0005 inches for it to vector. Both of these settings are the smallest line widths that those versions can display.

## Appendix G - How To Get Help

### Step 1:

Determine exactly what the problem is. Try to recreate the problem and write down the circumstances in which the problem occurred. Be prepared to describe all pertinent information about the computer being used with the laser cutting and engraving system such as software, operating system and computer type. Have the serial number of the laser system available. The serial number tag is located on the back of the machine in the lower right corner. There is a second serial tag located behind the front door on the right side when you open it.

### Step 2:

Contact your local Sales Representative first to assist you in diagnosing the problem. If possible, call from a phone that is close to the laser engraving system so that the system can be operated while talking to our representative.

### Step 3:

If your local Sales Representative is unavailable, contact our Customer Service Department at:

Universal Laser Systems, Inc.  
Service/Parts Department  
7707 East Acoma Drive, Suite 108  
Scottsdale, AZ 85260  
Phone: 480-609-0297  
Fax: 480-609-1203  
Email: [service@ulsinc.com](mailto:service@ulsinc.com)  
M-F 8am – 5pm Arizona Time